

RIGOL

Quick Guide

DG1000Z Series Function/Arbitrary Waveform Generator

**Jan 2014
RIGOL Technologies, Inc.**

Guaranty and Declaration

Copyright

© 2013 RIGOL Technologies, Inc. All Rights Reserved.

Trademark Information

RIGOL is a registered trademark of RIGOL Technologies, Inc.

Publication Number

QGB09102-1110

Notices

- **RIGOL** products are protected by patent law in and outside of P.R.C.
- **RIGOL** reserves the right to modify or change parts of or all the specifications and pricing policies at company's sole decision.
- Information in this publication replaces all previously corresponding material.
- **RIGOL** shall not be liable for losses caused by either incidental or consequential in connection with the furnishing, use or performance of this manual as well as any information contained.
- Any part of this document is forbidden to be copied or photocopied or rearranged without prior written approval of **RIGOL**.

Product Certification

RIGOL guarantees this product conforms to the national and industrial standards in China as well as the ISO9001:2008 standard and the ISO14001:2004 standard. Other international standard conformance certification is in progress.

Contact Us

If you have any problem or requirement when using our products or this manual, please contact **RIGOL**.

E-mail: service@rigol.com

Website: www.rigol.com

Safety Requirement

General Safety Summary

Please review the following safety precautions carefully before putting the instrument into operation so as to avoid any personal injuries or damages to the instrument and any product connected to it. To prevent potential hazards, please use the instrument only specified by this manual.

Use Proper Power Cord.

Only the power cord designed for the instrument and authorized by local country could be used.

Ground The Instrument.

The instrument is grounded through the Protective Earth lead of the power cord. To avoid electric shock, it is essential to connect the earth terminal of power cord to the Protective Earth terminal before any inputs or outputs.

Observe All Terminal Ratings.

To avoid fire or shock hazard, observe all ratings and markers on the instrument and check your manual for more information about ratings before connecting.

Use Proper Overvoltage Protection.

Make sure that no overvoltage (such as that caused by a thunderstorm) can reach the product, or else the operator might expose to danger of electrical shock.

Do Not Operate Without Covers.

Do not operate the instrument with covers or panels removed.

Avoid Circuit or Wire Exposure.

Do not touch exposed junctions and components when the unit is powered.

Do Not Operate With Suspected Failures.

If you suspect damage occurs to the instrument, have it inspected by qualified service personnel before further operations. Any maintenance, adjustment or replacement especially to circuits or accessories must be performed by **RIGOL** authorized personnel.

Keep Well Ventilation.

Inadequate ventilation may cause increasing of temperature or damages to the device. So please keep well ventilated and inspect the intake and fan regularly.

Do Not Operate in Wet Conditions.

In order to avoid short circuiting to the interior of the device or electric shock, please do not operate in a humid environment.

Do Not Operate in an Explosive Atmosphere.

In order to avoid damages to the device or personal injuries, it is important to operate the device away from an explosive atmosphere.

Keep Product Surfaces Clean and Dry.

To avoid the influence of dust and/or moisture in air, please keep the surface of device clean and dry.

Electrostatic Prevention.

Operate in an electrostatic discharge protective area environment to avoid damages induced by static discharges. Always ground both the internal and external conductors of the cable to release static before connecting.

Handling Safety.

Please handle with care during transportation to avoid damages to buttons, knob interfaces and other parts on the panels.

Safety Terms and Symbols

Terms in this Manual. These terms may appear in this manual:

**WARNING**

Warning statements indicate the conditions or practices that could result in injury or loss of life.

**CAUTION**

Caution statements indicate the conditions or practices that could result in damage to this product or other property.

Terms on the Product. These terms may appear on the Product:

DANGER

indicates an injury or hazard may immediately happen.

WARNING

indicates an injury or hazard may be accessible potentially.

CAUTION

indicates a potential damage to the instrument or other property might occur.

Symbols on the Product. These symbols may appear on the product:



**Hazardous
Voltage**



**Safety
Warning**



**Protective
Earth
Terminal**



**Chassis
Ground**



**Test
Ground**

General Care and Cleaning

General Care:

Do not store or leave the instrument in where the instrument will be exposed to direct sunlight for long periods of time.

Cleaning:

Clean the instrument regularly according to its operating conditions. To clean the exterior surface, perform the following steps:

1. Disconnect the instrument from all power sources.
2. Clean the loose dust on the outside of the instrument with a lint- free cloth (with a mild detergent or water). When cleaning the LCD, take care to avoid scarifying it.



CAUTION

To avoid damages to the instrument, do not expose them to liquids which have causticity.



WARNING

To avoid injury resulting from short circuit, make sure the instrument is completely dry before reconnecting to a power source.

Environmental Considerations

The following symbol indicates that this product complies with the applicable European Union requirements according to Directives 2002/96/EC on waste electrical and electronic equipment (WEEE) and batteries.



Product End-of-Life Handling

The equipment may contain substances that could be harmful to the environment or human health. In order to avoid release of such substances into the environment and harm to human health, we encourage you to recycle this product in an appropriate system that will ensure that most of the materials are reused or recycled appropriately. Please contact your local authorities for disposal or recycling information.

Document Overview

Format Conventions in this Manual

1. Button

The key at the front panel is denoted by the format of “Text Box + Button Name (Bold)” in the manual, for example, **Sine**.

2. Menu:

The menu is denoted by the format of “Character Shading + Menu Word (Bold)” in the manual, for example, **Freq**.

3. Connector:

The connector at the front or rear panel is denoted by the format of “Square Brackets + Connector Name (Bold)” in the manual, for example, **[Counter]**.

4. Operation Steps:

The next step of the operation is denoted by an arrow “→” in the manual. For example, **Sine** → **Freq** denotes pressing **Sine** at the front panel and then pressing **Freq**.

Content Conventions in this Manual

- DG1000Z series function/arbitrary waveform generator includes DG1032Z and DG1062Z. In this manual, DG1062Z is taken as an example to illustrate the basic operations of the generator. For more details, please refer to DG1000Z Series Function/Arbitrary Waveform Generator User's Guide.

Model	Channels	Max. Frequency
DG1062Z	2	60MHz
DG1032Z	2	30MHz

- All models of DG1000Z series function/arbitrary waveform generator are equipped with dual channels (CH1 and CH2). Unless otherwise specified, this manual takes CH1 as an example to introduce the operation method which is also applied to CH2.

Manuals of this Product

The manuals of this product mainly include the quick guide, user's guide, programming guide and data sheet. For the newest version of the desired manual, download it from www.rigol.com.

Content

Guaranty and Declaration	I
Safety Requirement	II
General Safety Summary	II
Safety Terms and Symbols.....	III
General Care and Cleaning	IV
Environmental Considerations.....	IV
Document Overview	V
Quick Start	1
General Inspection.....	1
To Adjust the Handle.....	2
Appearance and Dimensions.....	3
Front Panel Overview	4
Rear Panel Overview	9
Power On and Inspection	11
To Connect to Power	11
Power-on Inspection	11
To Set the System Language	11
User Interface	12
Dual Channels Parameters Mode.....	12
Dual Channels Graph Mode	14
Single Channel Mode.....	14
To Use the Built-in Help System	15
Basic Operations	16
To Output Basic Waveform	16
To Output Arbitrary Waveform	17
To Output Harmonics	19
To Output AM Modulated Waveform	21
To Output FSK Modulated Waveform	22
To Output Sweep Waveform	23
To Output Burst Waveform	24
Remote Control	26
Troubleshooting	28

Quick Start

General Inspection

1. **Inspect the shipping container for damage**

Keep the damaged shipping container or cushioning material until the contents of the shipment have been checked for completeness and the instrument has passed both electrical and mechanical tests.

The consigner or carrier shall be liable for the damage to instrument resulting from shipment. **RIGOL** would not be responsible for free maintenance/rework or replacement of the unit.

2. **Inspect the instrument**

In case of any damage, or defect, or failure, notify your **RIGOL** sales representative.

3. **Check the accessories**

Please check the accessories according to the packing lists. If the accessories are incomplete or damaged, please contact your **RIGOL** sales representative.

To Adjust the Handle

To adjust the handle position of the instrument, please grip the handle by sides and pull it outward. Then, rotate the handle to the desired position. The operating method is shown below.

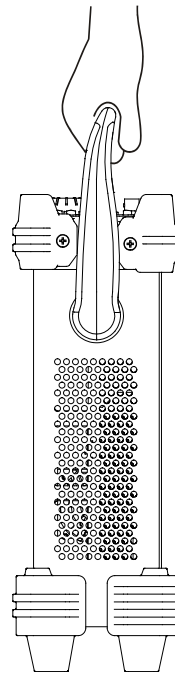
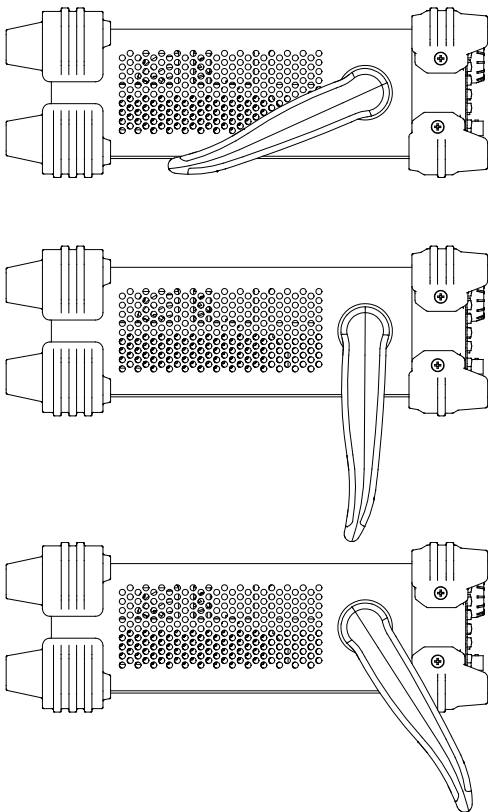
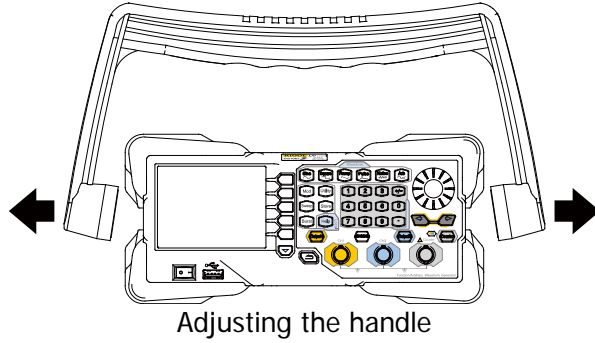

Appearance and Dimensions

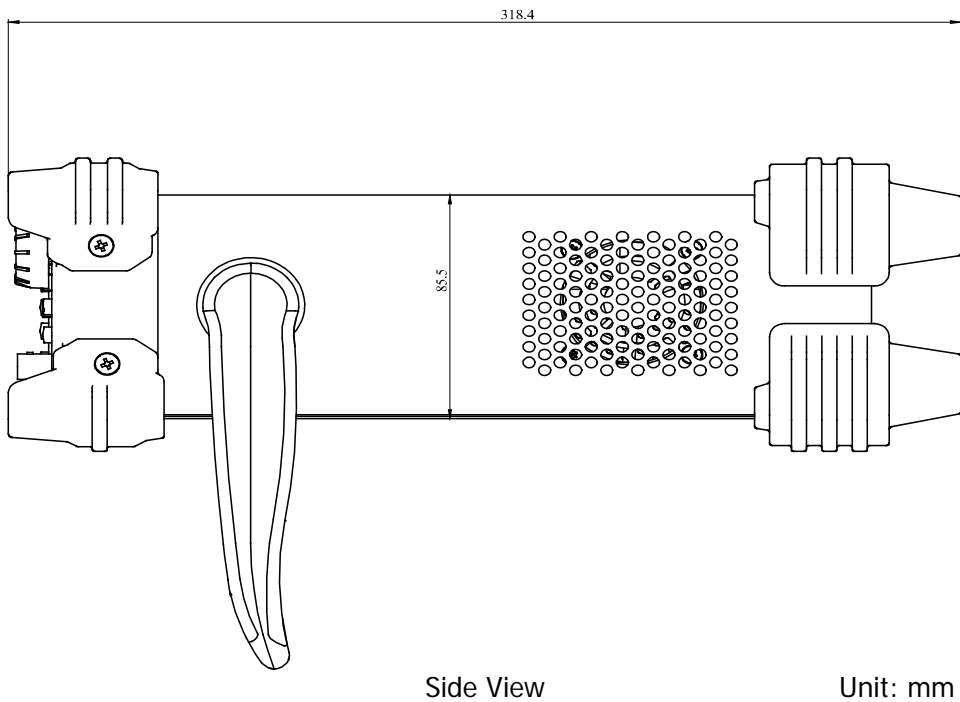
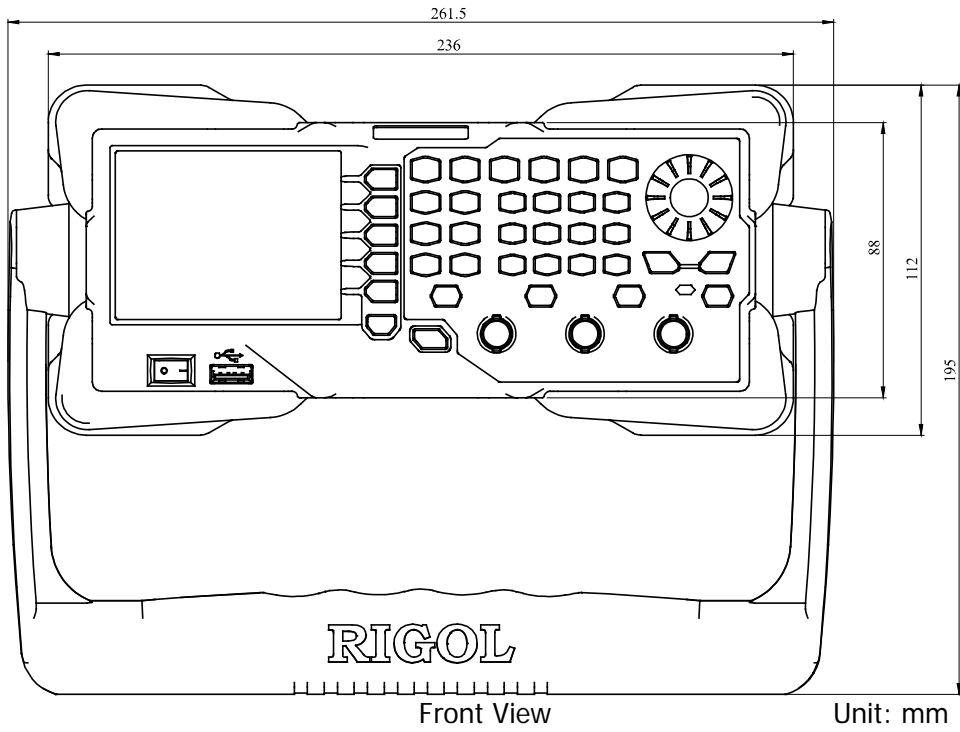

Front Panel Overview

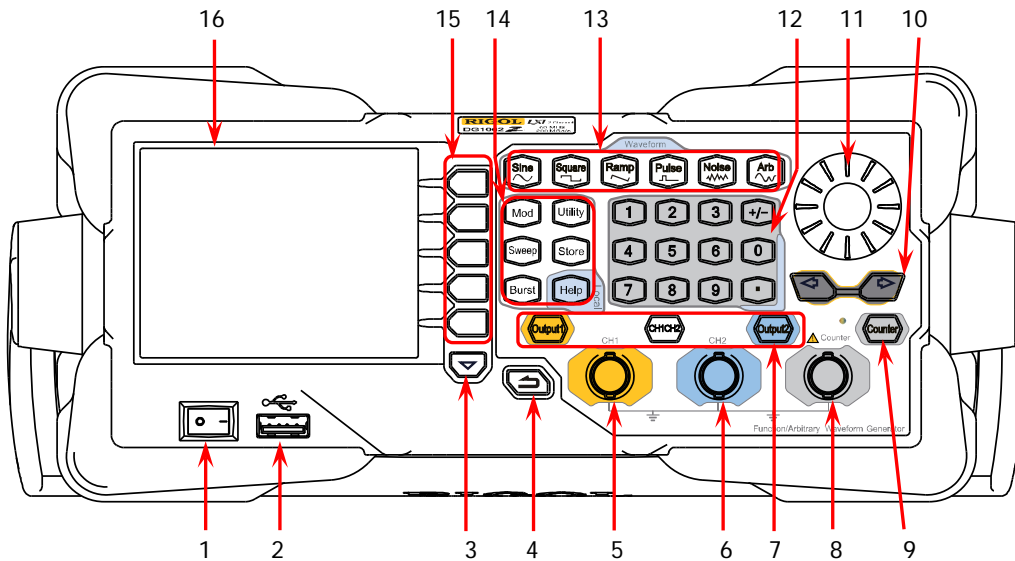

Figure 1 Front Panel

1. Power Key

The power key is used to turn the generator on or off.

2. USB Host

The USB Host interface is used to be connected an USB storage device to read the saved waveform or state files or store the current instrument state and edited waveform data into the USB storage device. In additional, the content displayed in the screen is also can be saved as a picture file (*.Bmp) in the USB storage device.

3. Page Down

This key is used to open the next page of the current menu.

4. Return to the Previous Menu

Quit the current menu and return to the previous menu.

5. CH1 Output Connector

BNC connector. The nominal output impedance is 50Ω .

When the **Output1** is enabled (the backlight goes on), this connector outputs the waveform based on the current settings of CH1.

6. CH2 Output Connector

BNC connector. The nominal output impedance is 50Ω .

When the **Output2** is enabled (the backlight goes on), this connector outputs the waveform based on the current settings of CH2.

7. Channel Control Area



Used to control the output of CH1.

- Press this key to open the output of CH1, the backlight goes on and the **[CH1]** connector outputs the waveform based on the current settings of CH1.
- Press this key again to close the output of CH1 and the backlight goes off.



Used to control the output of CH2.

- Press this key to open the output of CH2, the backlight goes on and the **[CH2]** connector outputs the waveform based on the current settings of CH2.
- Press this key again to close the output of CH2 and the backlight goes off.

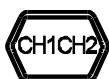

Used to switch the current selected channel between CH1 and CH2.



CAUTION

Overvoltage protection of CH1 and CH2 will take effect once any of the following conditions is met. When overvoltage protection takes effect, a message will be displayed and the output is disabled.

- The input voltage is higher than $\pm 11.5V \pm 0.1V$ when the amplitude of the generator is greater than 2Vpp or the DC offset is greater than $|2V_{DC}|$.
- The input voltage is higher than $\pm 3.5V \pm 0.1V$ when the amplitude of the generator is lower than or equal to 2Vpp or the DC offset is lower than or equal to $|2V_{DC}|$.

8. Input Connector for the Signal Measured by Counter

BNC connector. The input impedance is $1M\Omega$. This connector is used to accept the signal measured by the counter.



Note

To avoid damage to the instrument, the input signal voltage cannot exceed $\pm 7V_{ac+dc}$.

9. Counter

Used to turn the counter on or off.

- Press this key to turn the counter on, the backlight goes on and the indicator at the left of **Counter** blinks.
- Press this key again to turn the counter off and the backlight goes off.

10. Direction Keys

- Used to move the cursor to select the digit to be edited when setting parameter using knob.
- Used to delete the number at the left of the cursor when inputting parameter using numeric keyboard.
- Used to unfold or fold the selected directory when storing or reading file.
- Used to move the cursor to select the desired character in filename input area when editing filename.

11. Knob

- Used to increase (clockwise) or decrease (counterclockwise) the value marked by the cursor when setting parameter using knob.
- Used to select the storage location when storing a file or used to select the file to be read when reading file.
- Used to select a character from the virtual keyboard when editing filename.
- Used to select a desired built-in arbitrary waveform from **Arb** → **Select Wform** → **BuiltIn**.

12. Numeric Keyboard

The numeric keyboard consists of number keys (0 to 9), decimal point (.) and sign key (+/-) and is used to set the parameters.

Note:

- The sign key is used to switch between uppercase and lowercase inputs.
- Press the decimal point twice to save the content displayed in the user interface in the USB storage device in *.Bmp format.

13. Waveform Keys



Output Sine with frequency from 1 μ Hz to 60MHz.

- The backlight goes on when this function is selected.
- You can set the parameters for sine waveform including Freq/Period, Ampl/HiLevel, Offset/LoLevel and Start Phase.



Output Square with frequency from 1 μ Hz to 25MHz and variable duty cycle.

- The backlight goes on when this function is selected.
- You can set the parameters for square waveform including Freq/Period, Ampl/HiLevel, Offset/LoLevel, Duty Cycle and Start Phase.



Output Ramp with frequency from 1 μ Hz to 1MHz and variable symmetry.

- The backlight goes on when this function is selected.
- You can set the parameters for ramp waveform including Freq/Period, Ampl/HiLevel, Offset/LoLevel, Symmetry and Start Phase.



Output Pulse with frequency from 1 μ Hz to 25MHz and variable pulse width and edge times.

- The backlight goes on when this function is selected.
- You can set the parameters for pulse including Freq/Period, Ampl/HiLevel, Offset/LoLevel, Width/Duty, Leading, Trailing and Start Phase.



Output Gaussian Noise with 60MHz bandwidth.

- The backlight goes on when this function is selected.
- You can set the parameters for Noise including Ampl/HiLevel and Offset/LoLevel.



Output Arbitrary waveform with frequency from 1 μ Hz to 10MHz.

- Support two output modes:
Sample Rate and **Frequency**.
- Up to 160 built-in waveforms.
- The backlight goes on when this function is selected.
- You can set the parameters for Arb waveform including Freq/Period, Ampl/HiLevel, Offset/LoLevel and Start Phase.

14. Function Keys



Output multiple types of modulated waveforms.

- Support multiple modulation types: AM, FM, PM, ASK, FSK, PSK and PWM.
- Support internal and external modulation sources.
- The backlight goes on when this function is selected.



Output Sweep waveform for Sine, Square, Ramp and Arb (except DC).

- 3 Sweep types: Linear, Log and Step.
- 3 types of trigger sources: Internal, External and Manual.
- Provide frequency mark function used to control the status of the sync signal.
- The backlight goes on when this function is selected.



Output Burst waveform for Sine, Square, Ramp, Pulse and Arb (except DC).

- 3 Burst types: NCycle, Infinite and Gated.
- Noise can also be used to generate gated burst waveform.
- 3 types of trigger sources: Internal, External and Manual.
- The backlight goes on when this function is selected.



Used to set the auxiliary function parameters and system parameters. The backlight goes on when this function is selected.



Store or recall the instrument state or the user-defined arbitrary waveform data.

- A nonvolatile memory (C disk) is built in and an USB storage device (D disk) can be connected.
- The backlight goes on when this function is selected.



To get the help information of any front panel key or menu softkey, press this key and then press the desired key.

Note: when the instrument is working in remote mode, press this key to return to local mode.

15. Menu Softkeys

Correspond to the menus at the left and pressing the softkey will activate the corresponding menu.

16. LCD

3.5 inches TFT (320×240) color LCD display. The current settings and state of the instrument can be clearly displayed. For detailed information, refer to “**User Interface**”.

Rear Panel Overview

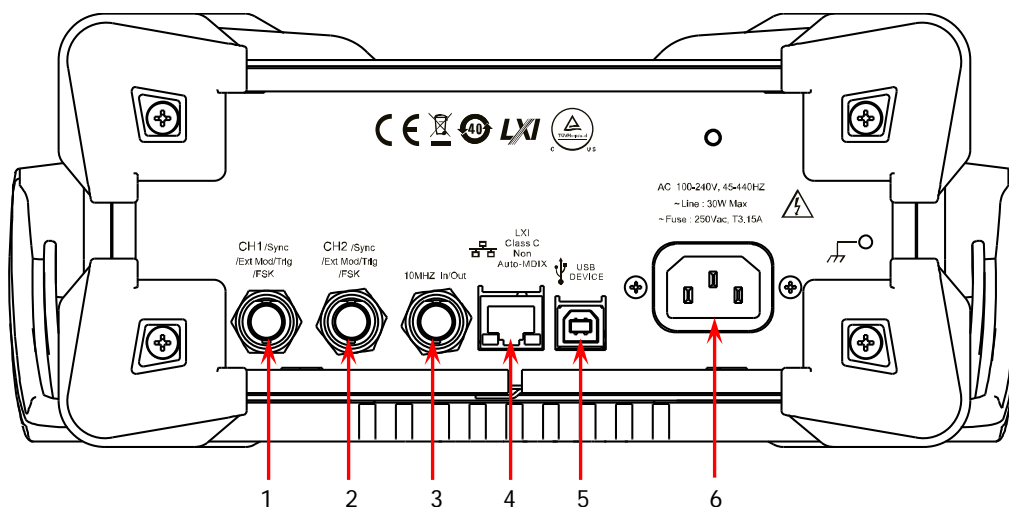

Figure 2 Rear Panel

1. [CH1/Sync/Ext Mod/Trig/FSK]

It is a BNC (female) connector which nominal impedance is 50Ω. The function of this connector is determined by the work mode of CH1.

- **Sync:** when the output of CH1 is enabled, this connector output the corresponding sync signal.
- **Ext Mod:** when AM, FM, PM or PWM of CH1 is enabled and external modulation source is selected, this connector accepts an external modulation signal.
- **FSK:** when ASK, FSK or PSK of CH1 is enabled and external modulation source is selected, this connector accepts an external modulation signal which polarity can be set by users.
- **Trig In:** when Sweep or Burst of CH1 is enabled and external trigger source is selected, this connector accepts an external trigger signal which polarity can be set by users.
- **Trig Out:** when Sweep or Burst of CH1 is enabled and internal or manual trigger source is selected, this connector outputs the trigger signal with specified edge type.

For more detailed information about the signals mentioned above, please refer to the User's Guide.

2. [CH2/Sync/Ext Mod/Trig/FSK]

It is a BNC (female) connector which nominal impedance is 50Ω. The function of this connector is determined by the work mode of CH2.

- **Sync:** when the output of CH2 is enabled, this connector output the corresponding sync signal.
- **Ext Mod:** when AM, FM, PM or PWM of CH2 is enabled and external

modulation source is selected, this connector accepts an external modulation signal.

- **FSK:** when ASK, FSK or PSK of CH2 is enabled and external modulation source is selected, this connector accepts an external modulation signal which polarity can be set by users.
- **Trig In:** when Sweep or Burst of CH2 is enabled and external trigger source is selected, this connector accepts an external trigger signal which polarity can be set by users.
- **Trig Out:** when Sweep or Burst of CH2 is enabled and internal or manual trigger source is selected, this connector outputs the trigger signal with specified edge type.

For more detailed information about the signals mentioned above, please refer to the User's Guide.

3. [10MHz In/Out]

It is a BNC (female) connector which nominal impedance is 50Ω. The function of this connector is determined by the type of the clock source.

- When internal clock source is selected, this connector (used as 10MHz Out) outputs the 10MHz clock signal generated by the internal crystal oscillator inside the generator.
- When external clock source is selected, this connector (used as 10MHz In) accepts an external 10MHz clock signal.

This connector is typically used to synchronize multiple generators. For more detailed information about the signals mentioned above, please refer to the User's Guide.

4. LAN Interface

Through this interface, the generator can be connected to your computer or the network of your computer for remote control. An integrated testing system may be built, as the generator conforms to the LXI-C class standard of LAN-based instrument control.

5. USB Device Interface

This interface is used to connect a computer which can control the generator remotely using PC software or by programming. It is also connected to a PictBridge printer to print the content displayed in the screen.

6. AC Power Socket

The AC power supply specification of this signal generator is 100-240V, 45-440Hz. The maximum input power of the instrument cannot exceed 30W. The specification of the fuse is 250V, T3.15A.

Power On and Inspection

To Connect to Power

Please connect the generator to AC power supply using the power cord supplied in the accessories as shown in the figure below. The AC power supply specification of this generator is 100-240V, 45-440Hz. The maximum input power of the instrument cannot exceed 30W. When the signal generator is connected to AC power supply via this connector, the instrument select the correct voltage range automatically and users do not need to select the voltage range manually.

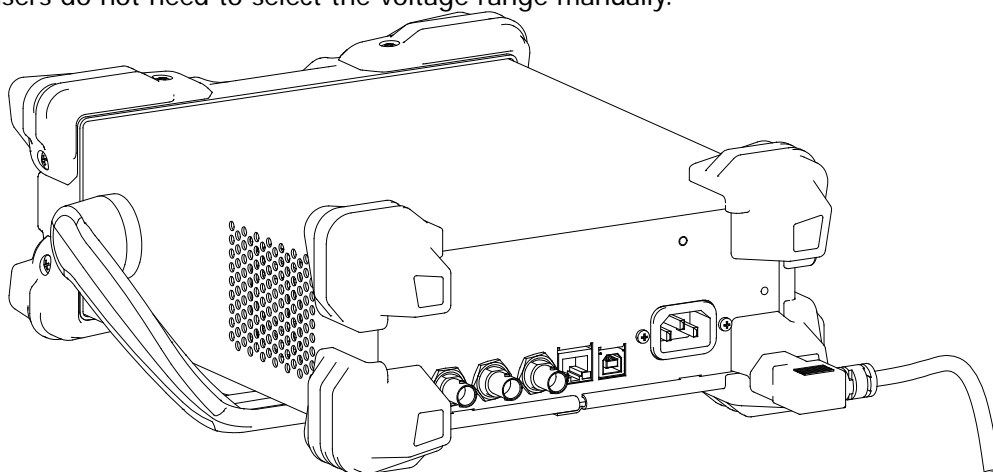



Figure 3 Connect to Power



CAUTION

To avoid electric shock, make sure that the instrument is correctly grounded.

Power-on Inspection

After the power supply is correctly connected, press the power key  at the front panel to turn on the generator. During the start-up, the instrument performs initialization and self-test. After that, the instrument enters the default interface. If the instrument does not start normally, please refer to the “**Troubleshooting**”.

To Set the System Language

DG1000Z series function/arbitrary generator supports Chinese and English system languages. You can press **Utility** → **Language** to switch the system language.

User Interface

The user interface of DG1000Z provides three types of display modes: **Dual Channels Parameters** (default), **Dual Channels Graph** and **Single Channel**. This manual mainly introduces the user interface taking the first display mode as an example.

Dual Channels Parameters Mode

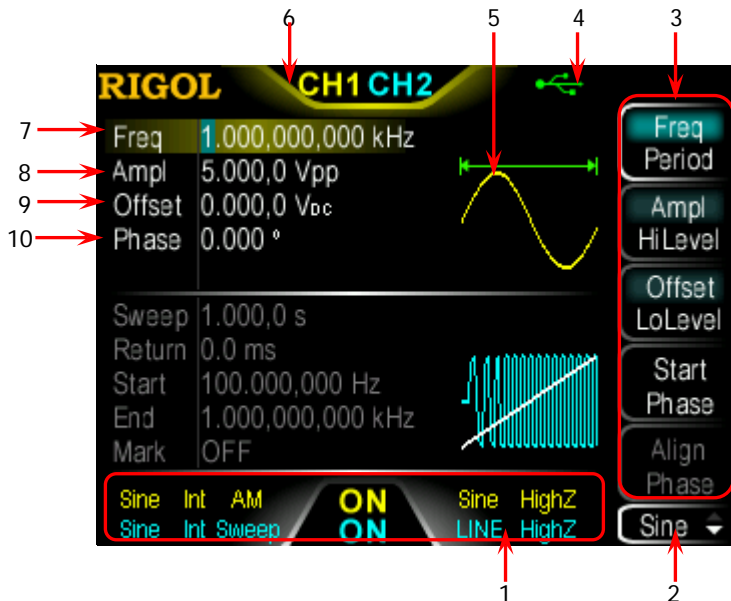

Figure 4 User Interface (Dual Channels Parameters Mode)

1. Channel Output Configuration Status Bar

Display the output configurations of the two channels.

Work Mode:
AM/FM/PM/ASK/FSK/PSK/
Mod (Displayed when PWM
is enabled)/Sweep/Burst

Modulation Waveform of Analog Modulation:
Sine/Square/Tria/UpRamp/DnRamp/Noise/Arb
Polarity of Digital Modulation: Pos/Neg
Type of Sweep: LINE/LOG/SEG
Type of Burst: Ncycle/INF/Gate

Selected Waveform:
Sine
Squ
Ramp
Pulse
Noise
Arb
Harm



Channel Output State:
ON/OFF

Type of Modulation Source: Int/Ext
Type of Sweep/Burst Trig Source:
Int/Ext/Mu

Type of Output Impedance:
High Impedance: display HighZ
Load: display impedance value
(the default is 50Ω and the range is 1Ω-10kΩ)

2. Current Function

Display the function name selected currently. For example, "Sine" is displayed when the sine is selected and "Edit" is displayed when the arbitrary waveform editing function is selected.

3. Menu

Display the operation menu of the function selected currently.

4. Status Bar



: Displayed when the instrument is connected to the LAN correctly.



: Displayed when the instrument is in remote mode.



: Displayed when an USB storage device is detected.

5. Waveform

Displayed the waveform currently selected by each channel.

6. Channel Status Bar

Used to indicating the selected status and on/off status of the channels. When CH1 is selected, the border of the bar is displayed in yellow. When CH2 is selected, the border of the bar is displayed in blue. When the output of CH1 is enabled, the "CH1" in the bar is highlighted in yellow. When the output of CH2 is enabled, the "CH2" in the bar is highlighted in blue.

Note: you can enable the outputs of the two channels but you cannot select the two channels at the same time.

7. Frequency

Display the waveform frequency of the channel. Press **Freq/Period** to highlight "Freq" and use the numeric keyboard or knob to modify this parameter.

8. Amplitude

Display the waveform amplitude of the channel. Press **Ampl/HiLevel** to highlight "Ampl" and use the numeric keyboard or knob to modify this parameter.

9. Offset

Display the waveform DC offset of the channel. Press **Offset/LoLevel** to highlight "Offset" and use the numeric keyboard or knob to modify this parameter.

10. Phase

Display the waveform start phase of the channel. Press **Start Phase** and use the numeric keyboard or knob to modify this parameter.

Dual Channels Graph Mode

Press **Utility** → **System** → **Display** → **DispMode** to select “Dual Graph”, as shown in the figure below.

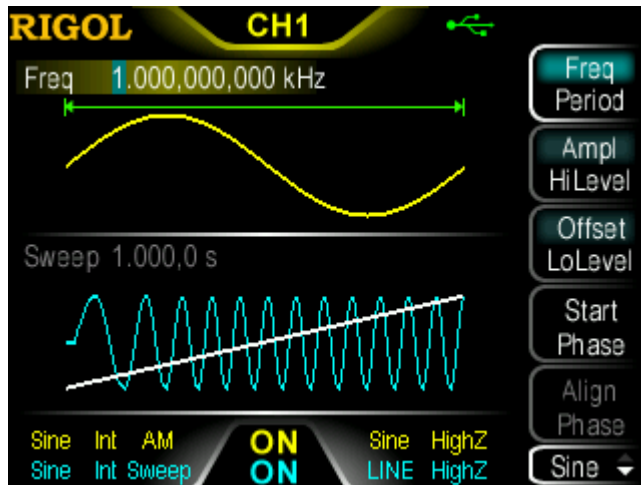

Figure 5 User Interface (Dual Channels Graph Mode)

Single Channel Mode

Press **Utility** → **System** → **Display** → **DispMode** to select “Single View”, as shown in the figure below.

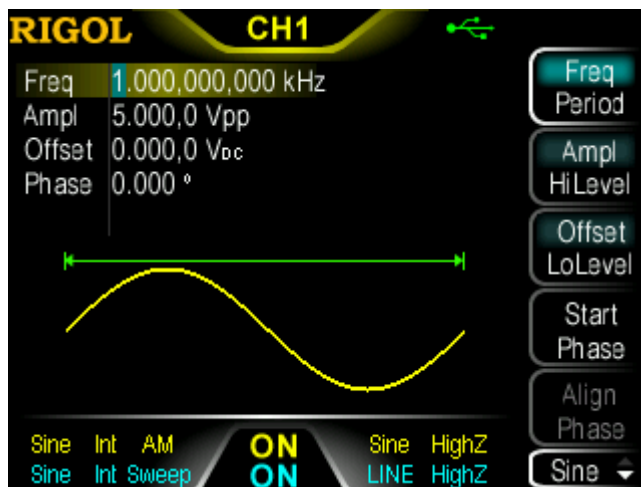

Figure 6 User Interface (Single Channel Mode)





To Use the Built-in Help System

The built-in help system of DG1000Z provides help information for each key and menu softkey at the front panel. Users can view the help of any key when operating the instrument.

1. Acquire the built-in help

Press **Help** and the backlight goes on. Then press the desired key or menu softkey and the corresponding help information is displayed.





2. Page up/down

When the help information is displayed on multiple pages, users can acquire the help information on the previous or next page using  (the previous line)/ (the next line)/ (page up)/ (page down) or the knob.

3. Turn off the current help information

When the help information is displayed in the interface, pressing any function key (except **Output1** and **Output2**) at the front panel will turn off the help information currently displayed.

4. Main Help Topics

Press **Help** twice to open the list of main help topics. Use /// or the knob to select the desired help topic and press **Select** to view the corresponding help information.

Basic Operations

To Output Basic Waveform

DG1000Z can output basic waveforms (Sine, Square, Ramp, Pulse and Noise) from one of the channels separately or from the two channels at the same time. This section introduces how to output a sine waveform (Frequency: 20kHz, Amplitude: 2.5Vpp, DC Offset: 500mV_{DC}, Start Phase: 90°) from the [CH1] connector.

1. To select output channel

Press **CH1 | CH2** to select CH1. Now the border of the channel status bar is displayed in yellow.

2. To select the Sine

Press **Sine** to select the sine waveform. The backlight goes on and the corresponding menu is displayed in the right of the screen.

3. To set the frequency/period

Press **Freq/Period** to highlight "Freq", and then use the numeric keyboard to input 20. Then select kHz from the pop-up menu.

- The frequency ranges from 1μHz to 60MHz.
- The frequency units available are MHz, kHz, Hz, mHz and μHz.
- Press this softkey again to switch to period setting.
- The period units available are sec, msec, μsec and nsec.

4. To set the amplitude

Press **Ampl/HiLevel** to highlight "Ampl", and use the numeric keyboard to input 2.5. Then, select Vpp from the pop-up menu.

- The amplitude range is limited by the impedance and frequency/period.
- The amplitude units available are Vpp, mVpp, Vrms, mVrms and dBm (dBm is only valid when the setting in **Utility** → **Channel Set** → **Output Set** → **Imped** is not HighZ).
- Press this softkey again to switch to high level setting.
- The high level units available are V and mV.

5. To set the offset

Press **Offset/LoLevel** to highlight "Offset", and then use the numeric keyboard to input 500. Then, select mV_{DC} from the pop-up menu.

- The range of the offset is limited by the impedance and frequency/period.
- The DC offset voltage units available are V_{DC} and mV_{DC}.
- Press this softkey again to switch to low level setting. The low level must be lower than the high level at least 1mV (when the output impedance is 50Ω).
- The low level units available are V and mV.

6. To set the start phase

Press **Start Phase**, and then use the numeric keyboard to input 90. Then, select ° from the pop-up menu. The start phase ranges from 0° to 360°.

7. To enable the output

Press **Output1** to turn CH1 output on. At this point, the backlight goes on and the **[CH1]** connector outputs waveform with the specified parameters.

8. To observe the output waveform

Connect the **[CH1]** connector to the oscilloscope using BNC cable. The waveform is as shown in the figure below.

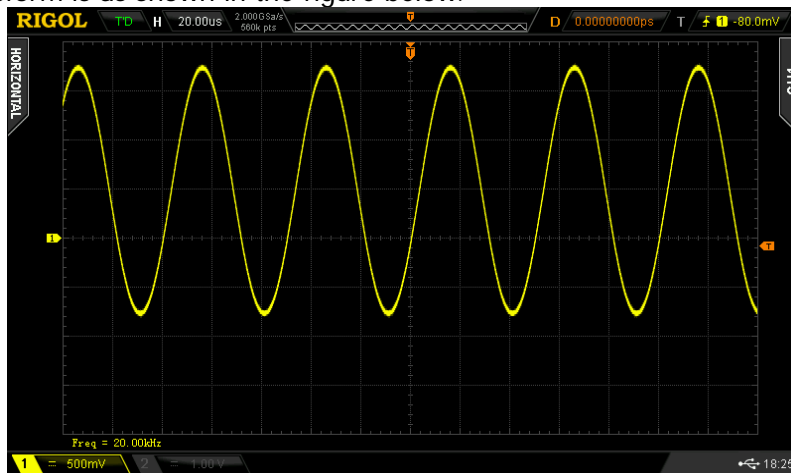

Figure 7 Sine

To Output Arbitrary Waveform

DG1000Z can output the built-in or user-defined arbitrary waveforms from a single channel or from two channels at the same time. This section introduces how to output an arbitrary waveform from the **[CH1]** connector (Edit Points, Sample editing mode, Cycle Period: 1s, HiLevel: 4V, LoLevel: -2V, Points: 8, Voltage of Point#1 to Point#4: 4V; Voltage of Point#5 to Point#8: -2V).

1. To select output channel

Press **CH1 | CH2** to select CH1. Now the border of the channel status bar is displayed in yellow.

2. To enable arbitrary waveform

Press **Arb** to enter the arbitrary waveform setting interface. Please set the frequency, amplitude, offset and start phase of the arbitrary waveform according to "To Output Basic Waveform".

3. To edit arbitrary waveform

Press **Arb** → **Edit Wform** to open the arbitrary waveform editing menu.

- 1) Press **Mode** to select "Sample".
- 2) Press **Cycle Period**, use the numeric keyboard to input 1 and select sec from the pop-up menu.
- 3) Press **HiLevel**, use the numeric keyboard to input 4 and select V from the pop-up menu.
- 4) Press **LoLevel**, use the numeric keyboard to input -2 and select V from the pop-up menu.
- 5) Press **Points**, use the numeric keyboard to input 8 and press **Sure**. At this point, a -2V level line appears.
- 6) Press **Edit Points** to enter the points editing interface.
 - Press **Sample** to define the first point. Press **Voltage**, use the numeric keyboard to input 4 and select V from the pop-up menu.
 - Press **Sample** again, use the numeric keyboard or knob to select point 2; then press **Voltage** to input 4V.
 - Define the voltage of point 3 to point 8 according to the method mentioned above.

4. To select waveform

Press **Arb** → **Select Wform** → **Volatile Wform** to select the waveform edited.

5. To enable the output

Press **Output1** to turn CH1 output on. At this point, the backlight goes on and the **[CH1]** connector outputs arbitrary waveform with the specified parameters.

6. To observe the output waveform

Connect the **[CH1]** connector to the oscilloscope using BNC cable. Now, you can observe the waveform via the oscilloscope.

To Output Harmonics

DG1000Z can be used as a harmonic generator to output harmonic with specified order, amplitude and phase. This section introduces how to output the 2nd and 4th harmonics from the [CH1] connector (Amplitude: 2Vpp and 1Vpp, Phase: 30° and 50°, Order: 5).

1. To select output channel

Press **CH1 | CH2** to select CH1. Now the border of the channel status bar is displayed in yellow.

2. To set the parameters of the fundamental waveform

Set the frequency/period, amplitude/high level, offset/low level and start phase of the fundamental waveform according to "To Output Basic Waveform".

3. To enable the harmonic function

Press **Sine** → **Harm** to select "On". Press **Harmonic Para** to enter the harmonic setting menu.

4. To set harmonic order

Press **Order** in the harmonic setting menu, use the numeric keyboard to input 5 and press **Sure**.

- The range is limited by the maximum output frequency of the instrument as well as the fundamental waveform frequency.
- Range: integers within 2 to **maximum output frequency of the instrument ÷ fundamental waveform frequency**. The maximum is 8.

5. To select harmonic type

Press **Type** in the harmonic setting menu to select Even or User.

Method 1: Even

Press this key and the instrument would output fundamental waveform and even harmonics (the 2nd and 4th harmonics).

Method 2: User

Press this key and the instrument would output the user-defined orders of harmonics. The highest order is 8.

8 bits binary data is used to represent the output status of the 8 orders of harmonics respectively, wherein, 1 represents enabling the output of the corresponding harmonic and 0 represents disabling the output of the corresponding harmonic. Users only need to use the numeric keyboard to modify the value of each data bit (note: the leftmost bit representing fundamental waveform is always X and cannot be modified). For example, set the 8 bits data to X101 0000, thus 2nd and 4th orders of harmonics are output.

Note: the actual harmonics output is determined by the "Order" and "Type" currently specified.

6. To set harmonic amplitude

Press **Harmonic Ampl** in the harmonic setting menu to set the amplitude of the 2nd and 4th harmonics.

- 1) Press **SN**, use the numeric keyboard to input 2 and press **Sure**.
- 2) Press **Harmonic Ampl**, use the numeric keyboard to input 2 and select Vpp from the pop-up menu.
- 3) Set the amplitude of the 4th harmonic to 1Vpp according to 1) and 2).

7. To set harmonic phase

Press **Harmonic Phase** in the harmonic setting menu to set the phase of the 2nd and 4th harmonics.

- 1) Press **SN**, use the numeric keyboard to input 2 and press **Sure**.
- 2) Press **Harmonic Phase**, use the numeric keyboard to input 30 and select ° from the pop-up menu.
- 3) Set the phase of the 4th harmonic to 50° according to 1) and 2).

9. To enable the output

Press **Output1** to turn CH1 output on. At this point, the backlight goes on and the **[CH1]** connector outputs the fundamental waveform as well as the 2nd and 4th harmonics.

10. To observe the output waveform

Connect the **[CH1]** connector to the oscilloscope using BNC cable. The waveform is as shown in Figure 9.

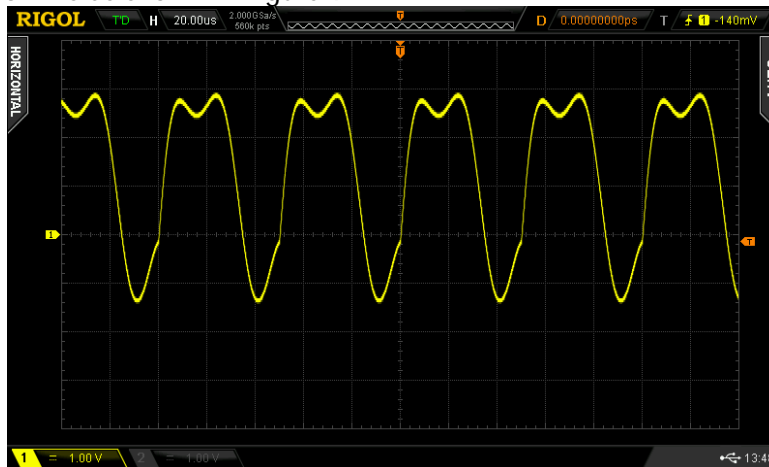

Figure 8 Harmonics

To Output AM Modulated Waveform

For amplitude modulation (AM), the amplitude of the carrier waveform varies with the instantaneous voltage of the modulating waveform. This section introduces how to output AM modulated waveform from the **[CH1]** connector (the carrier is sine with 5kHz frequency and 5Vpp amplitude, the modulating waveform is sine with 200Hz frequency and the modulation depth is 80%).

1. To select output channel

Press **CH1 | CH2** to select CH1. Now the border of the channel status bar is displayed in yellow.

2. To set the carrier waveform shape, frequency and amplitude

- 1) Carrier Waveform Shape: press **Sine** to select sine as the carrier waveform.
- 2) Carrier Frequency: press **Freq/Period** to highlight "Freq". At this point, use the numeric keyboard to input 5. Then, select kHz from the pop-up menu.
- 3) Carrier Amplitude: press **Ampl/HiLevel** to highlight "Ampl", and then use the numeric keyboard to input 5. Then, select Vpp from the pop-up menu.

3. To select AM modulation

Press **Mod** → **Type** → **AM** to enable AM function.

- When **Mod** is enabled, **Sweep** or **Burst** will be disabled automatically (if enabled currently).
- **Int** and **AM** will be displayed in the bottom of the screen.

4. To set Modulating waveform frequency

Press **AM Freq**, and then use the numeric keyboard to input 200. Then, select Hz from the pop-up menu.

5. To select modulating waveform

Press **Shape** to select Sine from the pop-up menu.

6. To set modulation depth

Press **AM Depth**, and then use the numeric keyboard to input 80. Then, select % from the pop-up menu.

7. To enable the output

Press **Output1** to turn CH1 output on. At this point, the backlight goes on and the **[CH1]** connector outputs the AM modulated waveform based on the current settings.

8. To observe the output waveform

Connect the **[CH1]** connector to the oscilloscope using BNC cable. The waveform is as shown in the figure below.

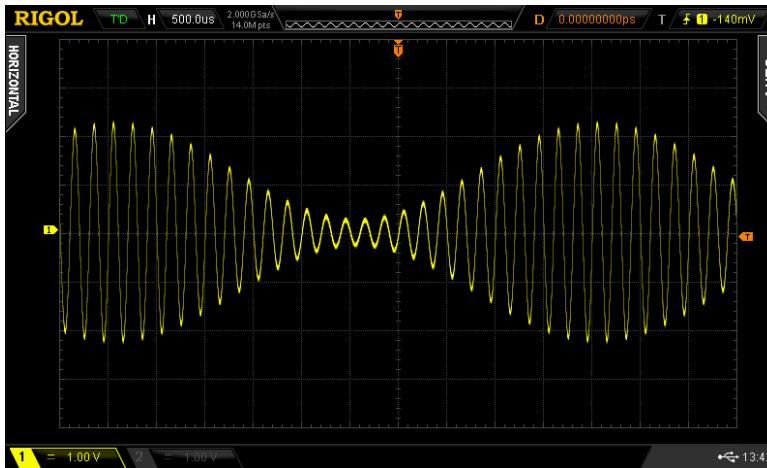

Figure 9 AM Modulated Waveform

To Output FSK Modulated Waveform

For FSK (Frequency Shift Keying) modulation, the generator “shifts” its output frequency between two preset frequencies (carrier frequency and hop frequency). This section introduces how to output FSK modulated waveform from the [CH1] connector (the carrier is sine with 3kHz frequency and 5Vpp amplitude, the hop frequency is 500Hz, the FSK rate is 100Hz and the modulating polarity is Pos).

1. To select output channel

Press **CH1 | CH2** to select CH1. Now the border of the channel status bar is displayed in yellow.

2. To set the carrier waveform shape, frequency and amplitude

- 1) Carrier Waveform Shape: press **Sine** to select sine as the carrier waveform.
- 2) Carrier Frequency: press **Freq/Period** to highlight “Freq”. At this point, use the numeric keyboard to input 3. Then, select kHz from the pop-up menu.
- 3) Carrier Amplitude: press **Ampl/HiLevel** to highlight “Ampl”, and then use the numeric keyboard to input 5. Then, select Vpp from the pop-up menu.

3. To select FSK modulation

Press **Mod** → **Type** → **FSK** to enable FSK function.

- When **Mod** is enabled, **Sweep** or **Burst** will be automatically disabled (if enabled currently).
- **Int** and **FSK** will be displayed in the bottom of the screen.

4. To set hop frequency

Press **Hop Freq**, use the numeric keyboard to input 500 and select Hz from the pop-up menu.

5. To set FSK rate

Press **FSK Rate**, use the numeric keyboard to input 100 and select Hz from the pop-up menu.

6. To set modulating polarity

Press **Polarity** to select the Pos polarity of the modulating waveform to control the output frequency. At this point, the generator would output the carrier frequency when the modulating waveform is logic low and output the hop frequency when the modulating waveform is logic high.

7. To enable the output

Press **Output1** to turn CH1 output on. At this point, the backlight goes on and the **[CH1]** connector outputs the FSK modulated waveform based on the current settings.

8. To observe the output waveform

Connect the **[CH1]** connector to the oscilloscope using BNC cable. Now, you can observe the waveform via the oscilloscope.

To Output Sweep Waveform

DG1000Z can output sweep waveform from a single channel or from dual channels at the same time. This section introduces how to output sweep waveform from the **[CH1]** connector (Linear sweep type, the carrier is sine with 5Vpp amplitude, the frequency range is 50Hz~1kHz, Sweep Time: 1s, Internal trigger source).

1. To select output channel

Press **CH1 | CH2** to select CH1. Now the boarder of the channel status bar is displayed in yellow.

2. To set the carrier waveform shape and amplitude for sweep

- 1) Waveform: Press **Sine** to select sine as the carrier waveform.
- 2) Amplitude: Press **Ampl/HiLevel** to highlight "Ampl", and then use the numeric keyboard to input 5. Then, select Vpp from the pop-up menu.

3. To enable sweep function

Press **Sweep** to enable the sweep function (the backlight of the key goes on).

- When **Sweep** is enabled, **Mod** or **Burst** function will be automatically disabled (if currently enabled).
- **Int** and **Sweep** will be displayed in the bottom of the screen.

4. To select sweep type

Press **Type** to select Linear. At this point, a white line appears on the waveform in the screen as shown in the right figure.



5. To set the start frequency and stop frequency

- 1) Start Frequency
Press **Start/Center** to highlight "Start", and then use the numeric keyboard to input "50". Then, select Hz from the pop-up menu.
- 2) Stop Frequency
Press **Stop/Span** to highlight "Stop", and then use the numeric keyboard to input 1. Then, select Hz from the pop-up menu.

6. To set the sweep time

Press **Sweep Time** to input 1 using the numeric keyboard and select sec from the pop-up menu.

7. To select the trigger source

Press **Trigger** → **Source** to select Int trigger source.

9. To enable the output

Press **Output1** to turn CH1 output on. At this point, the backlight goes on and the **[CH1]** connector outputs the sweep waveform based on the current settings.

10. To observe the output waveform

Connect the **[CH1]** connector to the oscilloscope using BNC cable. Now, you can observe the waveform via the oscilloscope.

To Output Burst Waveform

DG1000Z can output waveform with specified number of cycles (called burst) from a single channel or from dual channels at the same time. This section introduces how to output burst from the **[CH1]** connector (3 cycles, the carrier is sine with 5Vpp amplitude and 1ms period, Burst Period: 10ms, Internal trigger source, Delay: 1ms).

1. To select output channel

Press **CH1|CH2** to select CH1. Now the border of the channel status bar is displayed in yellow.

2. To set the carrier waveform shape and amplitude for burst

- 1) Waveform: Press **Sine** to select sine as the carrier waveform.
- 2) Amplitude: Press **Ampl/HiLevel** to highlight "Ampl", and then use the numeric keyboard to input 5. Then, select Vpp from the pop-up menu.
- 3) Period: Press **Freq/Period** to highlight "Period", and then use the numeric keyboard to input 1. Then, select msec from the pop-up menu.

3. To enable burst function

Press **Burst** to enable the burst function (the backlight of the key goes on).

- When **Burst** is enabled, **Mod** or **Sweep** function will be automatically

- disabled (if currently enabled).
 - **Int** and **Burst** will be displayed in the bottom of the screen.
4. **To set the burst type and Cycles**
Press **Type** to select NCycle. At this point, the Cycles in the screen is highlighted and can be edited. Use the numeric keyboard to input 3 and press **Sure**.
 5. **To set burst period**
Burst period is only available for N cycle burst in internal trigger and is defined as the time from the start of a burst to the start of the next burst.
Press **Burst Period** to input 10 using the numeric keyboard and select msec from the pop-up menu.
 6. **To select burst trigger source**
Press **Trigger** → **Source** to select Int trigger source.
 7. **To set the delay**
Burst delay is only available for N cycle and infinite burst type. It is defined as the time from when the generator receives the trigger signal to starts to output the N Cycle (or Infinite) burst. Press **Delay**, and then use the numeric keyboard to input 1. Then select msec from the pop-up menu.
 8. **To enable the output**
Press **Output1** to turn CH1 output on. At this point, the backlight goes on and the **[CH1]** connector outputs the burst waveform based on the current settings.
 9. **To observe the output waveform**
Connect the **[CH1]** connector to the oscilloscope using BNC cable. The waveform is as shown in the figure below.

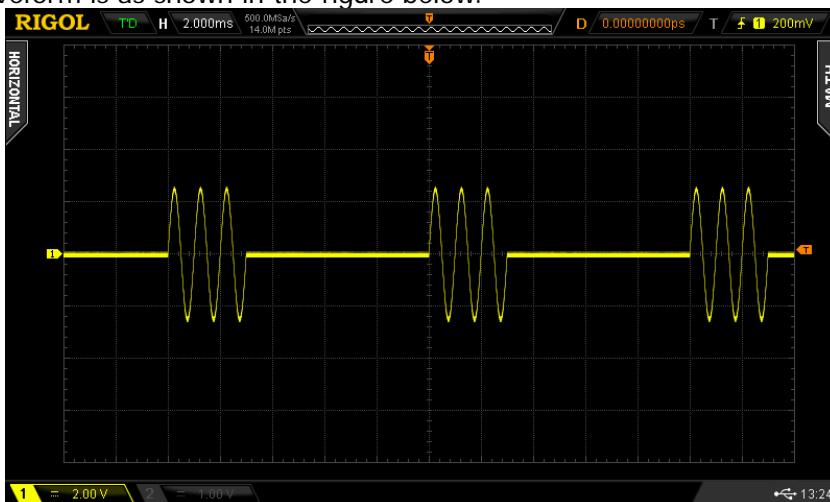



Figure 10 Burst

Remote Control

DG1000Z can communicate with PC through the USB, LAN or GPIB (option) interface to realize remote control on the basis of the SCPI commands (Standard Commands for Programmable Instruments). This section introduces how to control the generator remotely by sending the SCPI commands using **Ultra Sigma** provided by **RIGOL** via the USB interface. For detailed information about the commands, please refer to the Programming Guide.

When the instrument is working in remote mode, the  indicator is displayed in the screen and the keys (except **Help**) at the front panel are locked. Now you can return the instrument to local mode by pressing **Help**.

1. To install Ultra Sigma

Acquire the Ultra Sigma software and install it as well as its components according to the instructions. This software is contained in the resource CD in the standard accessories. You can also download the latest version of the software from www.rigol.com.

2. To control the generator via USB

1) Connect the device

Connect the generator (USB Device) and PC (USB Host) using USB cable.

2) Install USB drive

This generator is USB-TMC device and the **New Hardware Wizard** will be displayed after the generator is correctly connected to the PC (the generator will be automatically configured to USB interface) and both of them are started. Please install the "USB Test and Measurement Device" drive program according to the instructions.

3) Search for device resource

Start Ultra Sigma and the software will search for the generator resource currently connected to the PC automatically. You can also click

 to search for the resource manually.

4) View device resource

The resource found together with the instrument model and USB interface information will be displayed under the "RIGOL Online Resource" directory, as shown in Figure 12.



Figure 11 To View USB Instrument Resource

5) Communication test

Right-click the resource name DG1062Z

(USB0::0x1AB1::0x0642::DG1A000001::INSTR) and select SCPI Panel

Control to open the remote command control panel through which you can send commands and read data.



Figure 12 Send and Read Commands via USB

Troubleshooting

The commonly encountered failures and their solutions are listed below. When you encounter those problems, please solve them following the corresponding steps. If the problem remains still, please contact **RIGOL** and provide your device information (**Utility** → **System Info**).

1. **The screen of the generator is still dark (no display) after pressing the power key:**
 - 1) Check whether the power is correctly connected.
 - 2) Check whether the power key is really pressed.
 - 3) Restart the instrument after finishing the above inspections.
 - 4) If it still does not work correctly, please contact **RIGOL**.

2. **The screen is too dark and cannot be seen clearly:**
 - 1) Check whether the brightness setting of the LCD screen is too low.
 - 2) Press **Utility** → **System** → **Display** to enter the display setting menu. Press **Bright** and **Contrast** and use the numeric keyboard or the knob to adjust the brightness and contrast of the LCD screen to a proper value respectively.

3. **The generator is locked:**
 - 1) Check whether the generator is in remote control mode (in remote control,  is displayed in the status bar of the user interface). Pressing **Help** can exit the remote control mode and unlock the front panel.
 - 2) Restarting the generator can also unlock the instrument.

4. **The settings are correct but no waveform is generated:**
 - 1) Check if the BNC cable is tightly connected to the corresponding **[Output1]** or **[Output2]** connector.
 - 2) Check whether the connecting wire has internal damage.
 - 3) Check whether the BNC cable is tightly connected to the test instrument.
 - 4) Check whether the backlight of **Output1** or **Output2** goes on. If not, press corresponding key to illuminate the backlight.
 - 5) Press **Utility** → **System** → **Power On** to select Last and then restart the instrument after finishing the above inspections.
 - 6) If it does not work correctly, please contact **RIGOL**.

5. **The USB storage device cannot be recognized:**
 - 1) Check whether the USB storage device can work normally when connected to other instrument or PC.
 - 2) Make sure that the USB storage device used is Flash type. This instrument does not support hardware USB storage device.
 - 3) Restart the instrument and insert the USB storage again to check whether it can work normally.

- 4) If the USB storage device still cannot be used normally, please contact **RIGOL**.

6. How to set the amplitude of the waveform in dBm?

- 1) Press **CH1 | CH2** to select desired channel.
- 2) Check whether the setting in **Utility** → **Channel Set** → **Output Set** → **Imped** is HighZ. If yes, you cannot set the amplitude in dBm. Please press **Imped** to select Load and use the numeric keyboard or knob to set the impedance to a proper value.
- 3) Select desired waveform, press **Ampl/HiLevel** to highlight "Ampl", and then use the numeric keyboard to input desired value. Then select dBm from the pop-up menu.

7. Performance verification test is not passed:

- (1) Check whether the generator is within calibration period (1 year).
- (2) Make sure that the generator is warmed up for at least 30 minutes before test.
- (3) Check whether the generator is under the specified temperature.
- (4) Check whether the test is under the magnetic environment.
- (5) Check whether the power supplies of generator and test system have strong interference.
- (6) Check whether the performance of the test device meets the requirement.
- (7) Make sure that the test device is within calibration period.
- (8) Check whether the test device meets the required conditions of the manual.
- (9) Check whether all connections are tight.
- (10) Check whether all cables have internal damage.
- (11) Make sure that the operations conform to settings and processes which are required by the performance verification manual.
- (12) Check whether the error calculation is a mistake.
- (13) The definitions of "Typical Value" for this product should be correctly understood: the performance specification of this product under specified conditions.