



Dual laser + type K thermometer

INFRARED THERMOMETER

Model : ATE-2509



Your purchase of this INFRARED THERMOMETER marks a step forward for you into the field of precision measurement. Although this METER is a complex and delicate instrument, its durable structure developed. Please read the following instructions carefully and always keep this manual within easy reach.

OPERATION MANUAL

www.tmatlantic.com

TABLE OF CONTENTS

1. FEATURES.....	1
2. SPECIFICATIONS.....	2
3. FRONT PANEL DESCRIPTION.....	4
3-1 Emissivity Button.....	4
3-2 Down Button.....	4
3-3 LCD Display.....	4
3-4 Up Button.....	4
3-5 Mode Button.....	4
3-6 Measure Switch.....	4
3-7 Battery Cover.....	4
3-8 Infrared Lens.....	4
3-9 Laser.....	4
3-10 LED.....	4
3-11 Thermocouple Socket.....	4
4. MEASURING PROCEDURE.....	5
5. MEASURING CONSIDERATION.....	7
6. BATTERY REPLACEMENT.....	8
7. OPTIONAL TYPE K TEMP. PROBE.....	9

1. FEATURES

- * Non contact infrared temperature measurement up to 1,000 °C measurement.
- * Type K thermocouple thermometer, up to 1400 °C measurement.
- * Dual laser for better targeting.
- * Large LCD display with back light.
- * D/S ratio value : 50/1.
- * Min., Max., Differential, Average, Lock mode.
- * Last measurement memory.
- * Hi/Lo Temperature Audio Alarm.
- * Laser target and Back light On/Off control.
- * Adjustable emissivity value from 0.1 to 1.00.
- * Preset emissivity value at 0.95.
- * Power supply by two AAA batteries, long life.

2. SPECIFICATIONS

2-1 General Specifications

Display	LCD, 31 mm x 43 mm.
Functions	* °C, °F. * Min., Max., Differential, Average. * Lock mode. * Auto power off. * LCD back light. * Emissivity adjustment.
Infrared Temp. Measurement Range	-60 to 1000 °C (-76 to 1832 °F).

Infrared Temp. Accuracy	$\pm 1\text{ }^{\circ}\text{C}$ ($1.8\text{ }^{\circ}\text{F}$) <i>* Object Temp. = 15 to 35 $^{\circ}\text{C}$</i> <i>* Ambient Temp. = 25 $^{\circ}\text{C}$</i>	
	$\pm 2\%$ of reading or $\pm 2\text{ }^{\circ}\text{C}$ ($\pm 4\text{ }^{\circ}\text{F}$). whichever is greater. <i>* Object Temp. = -33 to 1000 $^{\circ}\text{C}$</i> <i>* Ambient Temp. = 23 \pm 3 $^{\circ}\text{C}$</i>	
Type K Thermometer Range	-64 to 1400 $^{\circ}\text{C}$ (-83.2 to 1999 $^{\circ}\text{F}$).	
Type K Thermometer Accuracy	$\pm 1\%$ of reading or $\pm 1\text{ }^{\circ}\text{C}$ ($\pm 1.8\text{ }^{\circ}\text{F}$), <i>* Test under T ambient = 23 \pm 5 $^{\circ}\text{C}$</i>	
Resolution	0.1 $^{\circ}\text{C}$ /0.1 $^{\circ}\text{F}$.	< 1,000 $^{\circ}\text{C}$ / $<$ 1,000 $^{\circ}\text{F}$
	1 $^{\circ}\text{C}$ /1 $^{\circ}\text{F}$.	\geq 1,000 $^{\circ}\text{C}$ / \geq 1,000 $^{\circ}\text{F}$
Circuit	Exclusive microcomputer circuit.	
Emissivity Adjustment	Adjustment range : 0.10 to 1.00, step 0.01. <i>* 0.95 default emissivity value.</i>	
Infrared Temp. Temp. Sensor	Thermocouple pie.	
Measurement Wave length Region	8 to 14 micro meter.	
Distance Factor	D/S : Approx. 50:1 (typical 25:1). D - Distance, S - Spot. <i>* Distance to spot using 90% encircled energy at focal point.</i>	
Target Guide	<i>* Two laser target guide.</i> <i>* Less than 1 mW.</i> <i>* Class 2 red laser diode. Wave length is 645 nm approximately.</i>	

Sampling Time	Approx. 0.7 second.
Power Supply	DC 1.5V AAA (UM-4) battery x 2 PCs, heavy duty or Alkaline.
Power Consumption	without target light on : <i>Approx. DC 1.5 mA.</i>
	with target light on : <i>Approx. DC 29.5 mA.</i>
Operating Temperature	0 to 50 °C (32 to 122 °F).
Operating Humidity	Less than 80% RH.
Weight	386 g/0.85 LB.
Dimension	203 x 197 x 47 mm (8.0 x 7.7 x 1.8 inch)
Standard Accessories	Operational manual.....1 PC. Magnetic stand..... 1 PC. Hard carrying case..... 1 PC. DC 1.5V AAA (UM-4) battery.....2 PC.
Optional Type K Temp. Probe	TP-01, TP-02, TP-03, TP-04, refer page 9

3. FRONT PANEL DESCRIPTION

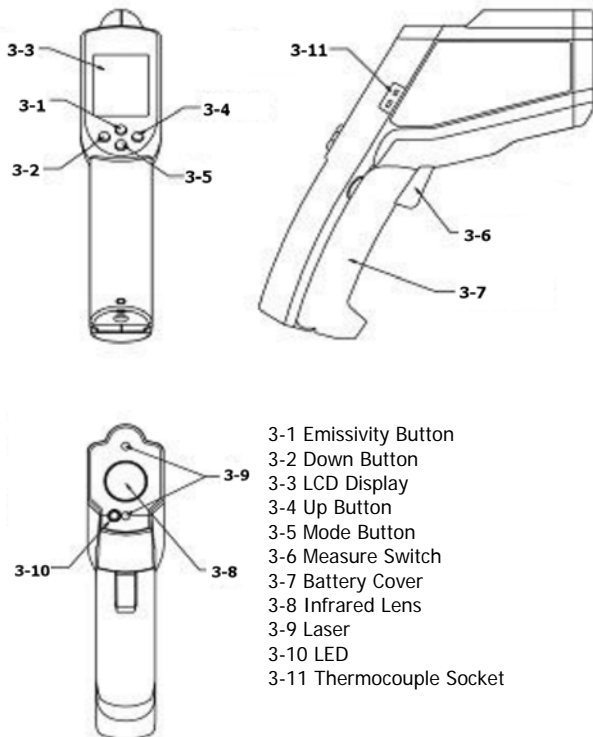

- 3-1 Emissivity Button
- 3-2 Down Button
- 3-3 LCD Display
- 3-4 Up Button
- 3-5 Mode Button
- 3-6 Measure Switch
- 3-7 Battery Cover
- 3-8 Infrared Lens
- 3-9 Laser
- 3-10 LED
- 3-11 Thermocouple Socket

Fig. 1

4. MEASURING PROCEDURES

1) Default LCD Screen

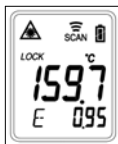





2) Simply aim the thermometer at the measure target with " Infrared Lens (3-8, Fig. 1) and press " Measure Button " (3-6, Fig. 1) to display the surface temperature. The Distance : Spot is 50:1. The two laser points are the reference for the target spot size. Please make sure the target area is within the field of view.

3) Press " Emissivity Button " (3-1, Fig. 1) for setting the emissivity

	Press " Emissivity Button " (3-1, Fig. 1), then press " Up Button " (3-4, Fig. 1) or Down key (3-2, Fig. 1) to set the emissivity, then press " Mode Button " (3-5, Fig. 1) to confirm it. The emissivity can be changed from 0.10 to 1 .
---	---

- 4) Press " Mode Button " (3-5, Fig. 1) for scrolling more display function as follows.



	Here will show the emissivity data. (The default emissivity is 0.95.)
	Press Mode key (3-5, Fig. 1) for the Maximum (MAX), Minimum (MIN), Different between MAX and MIN (DIF) and Average (AVG) modes. During the measurement, the special modes reading will be displayed beside the mode icon.
	Press " Up Button " (3-4, Fig. 1) or " Down Button " (3-2, Fig. 1) key to change the High Alarm (HAL) or Lo Alarm (LAL), then press " Measure Button " (3-6, Fig. 1) to confirm it. For example: When the reading $26.9\text{ }^{\circ}\text{C} < \text{LAL } 27\text{ }^{\circ}\text{C}$, the Low icon will flash and you will hear a beep sound.
	Connect the thermocouple with " Thermocouple Socket " (3-11, Fig. 1) and put the probe in/on the target, the thermometer will display the temperature automatically without pressing any button. To see the minimum or maximum data during the probe measurement, please hold down the " Up Button " (3-4, Fig. 1) or " Down Button " (3-2, Fig. 1).  After measure high temp, the probe may remain HOT for a while

- 5) The thermometer will automatically shut off if left idle for more than 60 seconds.

6) In MAX, MIN, DIF, AVG mode:

- a. Press " Up Button " (3-4, Fig. 1) for LOCK mode ON/OFF. The lock mode is particularly useful for continuous monitoring of temperatures for up to 60 minutes.
- b. Press " Down Button " (3-2, Fig. 1) for °C or °F transferred.



7) In all modes: First hold on the " Measure Button " (3-6, Fig. 1)



- a. and press " Up Button " (3-4, Fig. 1) for backlight function ON/OFF. 
- b. and press " Down Button " (3-2, Fig. 1) for laser function ON/OFF. (With flash light be turned on in the same time as laser) 

5. MEASURING CONSIDERATION

5-1 LCD error message



The thermometer incorporates visual diagnostic messages as follows

	Hi' or 'Lo' is displayed when the temperature being measured is outside of the settings of HAL and LAL.
	Er2' is displayed when the thermometer is exposed to rapid changes in the ambient temperature. 'Er3' is displayed when the ambient temperature exceeds 0 °C (32°F) or +50 °C (122°F). The thermometer should be allowed plenty of time (minimum 30 minutes) to stabilize to the working/room temperature.

	<p>Error 5-9, for all other error messages it is necessary to reset the thermometer. To reset it, wait for auto power off, remove the battery and wait for a minimum of one minute, reinsert the battery and turn on. If the error message remains please contact the Service Department for further assistance.</p>
	<p>" Hi " or " Lo " is displayed when the temperature being measured is outside of the measurement range.</p>

6. BATTERY REPLACEMENT

When the 'Low Battery' icon  indicates the battery is low, the battery should be replaced immediately with AAA, 1.5V batteries. Please note : It is important to turn the instrument off before replacing the battery otherwise the thermometer may malfunction.

	<p>Battery OK : Measurements are possible.</p>
	<p>Battery Low : Battery needs to be replaced, measurements are still possible.</p>
	<p>Battery Exhausted : Measurements are not possible</p>

7. OPTIONAL TYPE K TEMP. PROBE

(Type K) TP-01	<ul style="list-style-type: none"> * Max. short-tern operating Temperature: 300 °C (572 °F). * It is an ultra fast response naked-bead thermocouple suitable for many general purpose application.
Thermocouple Probe (Type K), TP-02A	<ul style="list-style-type: none"> * Measure Range: -50 °C to 900 °C, -50 °F to 1650 °F. * Dimension: 10cm tube, 3.2mm Dia.
Thermocouple Probe (Type K), TP-03	<ul style="list-style-type: none"> * Measure Range: -50 °C to 1200 °C, -50 °F to 2200 °F. * Dimension: 10cm tube, 8mm Dia.
Surface Probe (Type K), TP-04	<ul style="list-style-type: none"> * Measure Range: -50 °C to 400 °C, -50 °F to 752 °F. * Size : Temp. sensing head - 15 mm Dia. Probe length - 120 mm.