



AM-1018

OPERATION MANUAL

www.tmatlantic.com

Contents

Chapter 1 Safety Information

⊙ Meter Safety Standards.....	4
⊙ Warning.....	4
⊙ Limited Guarantee and the Liability Range.....	5

Chapter 2 Introduction to the Meter

⊙ Characteristics.....	6
⊙ Explanation on Front Panel.....	7
⊙ Understanding Display Screen.....	11
⊙ Function Descriptions.....	14

Chapter 3 Operation Methods

⊙ ACV Measurement.....	16
⊙ DCV Measurement.....	18
⊙ DC mV/AC mV Measurement.....	20
⊙ Logic Frequency/Duty Ratio/Temperature Measurement.....	22
⊙ Diode/ continuity Measurement.....	24
⊙ Resistance Measurement.....	26
⊙ Capacitance Measurement.....	28
⊙ DC μ A /AC μ A Measurement.....	30

⊙ DC mA/AC mA Measurement.....	32
⊙ Insulation Resistance Measurement.....	34
⊙ Linear Frequency Measurement.....	36
⊙ Maximum Value/Minimum Value/Average Measurement.....	37
⊙ Backlight Control.....	37
⊙ Data Hold.....	37
⊙ Automatic Shutdown and Continuous Operation Mode Selection.....	37
Chapter 4 Technological Specifications	
⊙ General Features.....	38
⊙ Range and Accuracy.....	39
Chapter 5 Maintenance	
⊙ Replacement of Batteries.....	43
⊙ Replacement of Fuse.....	43
⊙ Meter Calibration.....	44
⊙ Others	44

Chapter 1

Meter Safety Standards

This style of digital multimeter is designed and manufactured according to the safety requirements set out by the IEC61010-1 standards for electronic test instruments and the hand-held digital multimeters. Its design and manufacture is strictly based on the provisions in the 1000V CATIII of IEC6060-1 and the Stipulation of 2-Pollution Grade.

The meter conforms to the European Union's following requirements: 89/336/EEC (EMC Electromagnetic Compatibility), 73/23/EEC (LVD Low Voltage Protection) and 93/68/EEC (CE Mark).



Warning

- Before use of the meter firstly check up if there is any crack on the outer shell or if it lacks any plastic part, and check up whether the testing line is damaged or has any exposed metal. The meter can be used only if no any insulating problem be found.
- Carefully read the operating methods and safety prompts in this manual. Using it not based on the methods specified in this manual may cause the meter damaged.
- Non-normal meter must not be used. It should be sent for repairing.
- The meter must not be used in an environment with combustible gases, steam or dust pollution.
- It should be careful to work when measuring voltage higher than 30VAC (effective value) or 50VDC for such voltage having the risk of shock. Avoid the body directly touching ground or any metal substance in which there may be ground

potential during measuring. The body should be kept insulated from ground with dry insulating shoes, insulating pads or insulating clothes.

- When performing measurement with a test probe your fingers should be put behind a finger-protector.
- Must not try to measure a voltage higher than 1000VAC or 1000VDC, the meter may be damaged and the operator's safety may be threatened if the limit for voltage measurement be exceeded.
- When the symbol for electric insufficiency appearing on the display screen it is necessary to replace the batteries for avoiding the possible shock or injure resulted in by erroneous reading.
- In case of replacing batteries, it is necessary firstly to pull out the testing line. AA batteries should be used and they should be put into the meter with the proper polarity.
- Must not make any voltage measurement when the testing line being inserting into the current hole.
- Repair and calibration of the meter must be carried out by experienced professionals, unprofessional should not repair and calibrate the meter by themselves.

Limited Guarantee and the Liability Scope

This company will undertake repairs freely for any quality problem of the meter which if should be found within 18 months from the date at which it was bought, but which not including replacement of fuse and batteries as well as any damage caused by negligence, wrong use, pollution, change of circuit and non-normal use.

For maintenance beyond the 18-month guarantee period, the company will charge a certain repair fee and materials cost.

Chapter 2

Characteristics

- 5000 counts measurement
- ACV and DCV measurements reach up to 1000V.
- DC measurement accuracy reaches up to 0.1%.
- 0.1 Ω resistance resolution and 10 μ V voltage resolution.
- Linear frequency measurement, logic frequency/duty ratio measurement.
- Capacitance measurement from 0.1nF to 1000 μ F.
- AC/DC true RMS measurement.
- Maximum value/minimum value measurement.
- Insulation resistance measurement, range: 50k Ω to 2G Ω .
- Automatic shutdown/continuous working mode selection.
- Back light control.
- Overload protection.
- Secondary plasticizing meter shell, with insulating performance reaching 1000V CAT III.

(1)  end

The symbol consists of a 'V' for voltage, a 'Ω' for resistance, and 'I-+' for current measurement, with a frequency symbol 'Hz' below it.

It is the input end for all measurement functions except for current measurement and insulation resistance measurement, connected with a red meter probe. Hereinafter referred to as **V end**.

(2) **COM end**

It is the negative input end for all measurements except for insulation resistance measurement, connected with a black meter probe.

(3) **mA/μA end**

It is the positive end for measurement of mA or μA current, connected with a red meter probe. It is an end for measurement of the insulation resistance, connected with a black meter probe.

(4) **INS end**

It is the input end for insulation resistance measurement, connected with a red meter probe.

(5) **Rotary switch**

Used for selecting measurement functions such AC voltage, DC voltage, millivolt, frequency/temperature, diode/continue, resistance and capacitance, microampere current, milliampere current, insulation resistance.

(6) **POWER switch**

Used for putting on or off the operating power for the meter.

(7) **SELECT key**

- When setting the rotary switch to the position mV, μ A, mA, press the SELECT key to select the DC or AC mode.
- When setting the rotary switch to the position Hz %°C, press the SELECT key to select plus frequency, duty ratio or temperature mode.
- When setting the rotary switch to the position Diode/Continuity, press the SELECT key to select diode or continuity mode.
- Pressing this key will be void during the other measurement.
- If press down the SELECT key at the same time when turning on the power switch, the automatic sleep mode will be canceled.

(8)MAX/MIN key

Press MAX/MIN key to enter the record state for the maximum and minimum value. By pressing this key again it will display the minimum value, the maximum value, the average value and the current value in cycles. When releasing the key after pressing it for two seconds, the maximum and minimum record state will be exited.

(9)Hz/Duty key

- During the Frequency/Duty measurements state, by pressing Hz/DUTY key the meter will shift the frequency or duty measurement state.
- During the AC voltage or AC current measurements, by pressing Hz/DUTY key the meter will enter the linear frequency measurement state. At this time what being measured is the frequency of voltage or current. By pressing this key again to exit the linear frequency measurement state.

(10)LIGHT key

By pressing this key for a time, the backlight of the LCD screen will be opened and after ten seconds the meter will automatically turn off the backlight. It is also possible to turn off the backlight by pressing the LIGHT key before the ten seconds.

(11)TEST key

During the insulation resistance measurement state, press the TEST key to start measuring, and then press the TEST key again to stop measuring.

(12)RANGE key

- During the temperature measurement state, press the RANGE key to select Celsius or Fahrenheit.
- For various kinds of measurements it is used manually to select range. Under the automatic range state (AUTO RANGE displaying), it will enter manual range state(MANUAL RANGE displaying) with a press on RANGE, after that the range will be changed with a press on RANGE while the small digits on the left lower corner indicating the actual range. When the RANGE key being released after pressing for two seconds the meter will return back to the automatic state. When performing logic frequency measurement and diode measurement pressing RANGE will be void. During the insulation resistance measurement, the voltage range need to be selected by manual.

(13)BEEP key

When the short circuit is measured, press the BEEP key to select whether the buzzer sound.

(14)HOLD key

Used to maintain the measurement data unchanging, by pressing the key again it will resume the measurement.

(15)LCD screen

Used for displaying the measuring results and various symbols.

Understanding Display Screen :

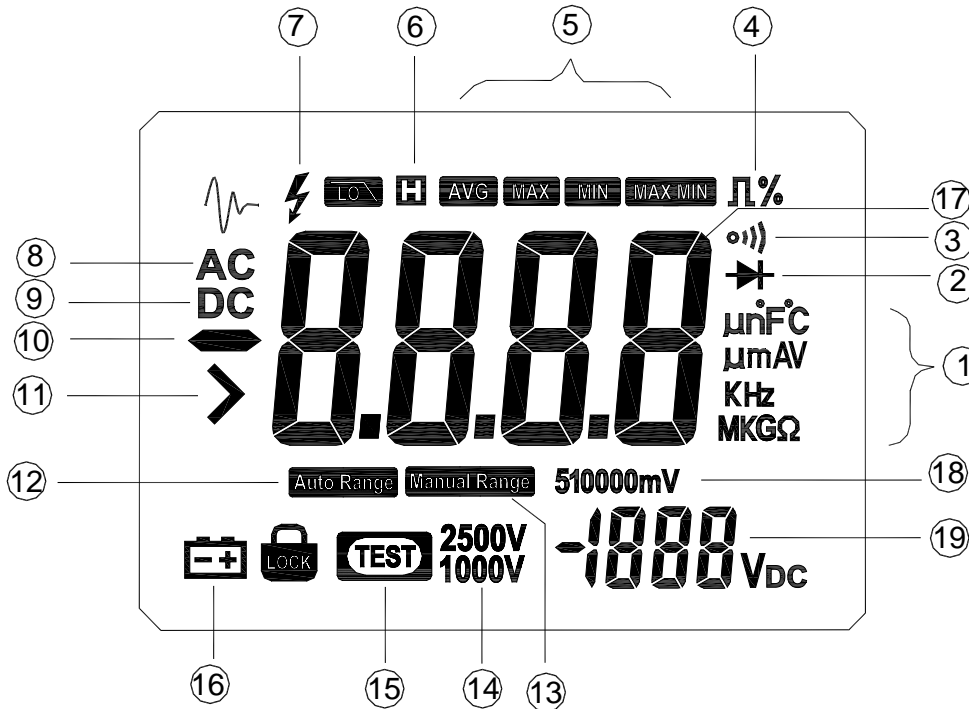









Figure 2-2

LCD screen is shown as in Figure 2-2, with its every symbol's meaning shown as in the Table 1:

Number of Order	Symbol	Functions
1	$\mu\text{n}^{\circ}\text{F}^{\circ}\text{C}$	Indicating the measurement unit being $^{\circ}\text{C}$ or $^{\circ}\text{F}$ of temperature or μF or nF of Capacitance
	μmAV	Indicating the measurement unit being μA , mA of current or μV and mV of voltage
	KHz	Indicating the measurement unit being KHz and Hz of frequency
	MKG Ω	Indicating the measurement unit being $\text{M}\Omega$, $\text{K}\Omega$, $\text{G}\Omega$ and Ω of resistance
2		Indicating it is now performing the diode measurement
3		Indicating it is now performing the continuity measurement
4	$\square\%$	Indicating it is now performing the duty measurement
5	AVG MAX MIN MAX MIN	Indicating the display value being the current value (MAX MIN), the maximum value (MAX), the minimum value (MIN) and the average value (AVG)
6		Indicating it is now in the data-holding state
7		Warning symbol that the input signal is the high-voltage
8	AC	Indicating it is now in the AC measurement state
9	DC	Indicating it is now in the DC measurement state

Tabell (continue)		
10		Indicating the measurement value being negative
11		Indicating the overload in the insulation resistance measurement
12	AUTO RANGE	Indicating the measurement being automatic range
13	MANUAL RANGE	Indicating the measurement being manual range
14	2500V 1000V	Indicating the range of excitation voltage when performing the insulation resistance measurement
15	TEST	Indicating it is now in the insulation resistance measurement state
16		Indication to low voltage of the batteries, showing the energy of batteries will be exhausted soon
17		The display zone for the meter's measurement value, showing all the measurement values
18	51000	Indicator of range, indicating the full range value of this range in manual range such as 5, 50, 500 and 1000, 5000, etc.
19	-1888VDC	Real-time display of the excitation voltage value when performing the insulation resistance measurement

Function Descriptions

Along with the conventional measurement functions this meter also possesses some special functions which being described as follows:

- True effective value (TRUE RMS) measurement: all the measurement values of this meter on the AC voltage and AC current are true effective values, which distinguishing this meter from the meters which only can measure the AC average value.
- Automatic and manual ranges: When turning on the meter's power switch the meter defaults the automatic range state (AUTO displaying), and simultaneously it will automatically select the proper range according to the measured electric parameters. If OL being displayed under automatic range, it indicates the measured value exceeding the meter's maximum range. Pressing the RANGE key under the automatic range the meter will enter the manual range (MANUAL displaying), then pressing the RANGE key again it will be possible to select the required range. The indicator for range will display the maximum value of this range. If OL displaying under the manual range, it indicates the measured value exceeding the selected range. Press the RANGE key under the manual range for two seconds and then release it, the meter will go back to the automatic range state.
- Linear frequency measurement: Pressing the Hz/Duty key when the meter performing measurements on AC voltage or current, it will be capable to measure the frequency of the AC component. However it has a certain requirements on the amplitude of the AC component.
- Logic impulse duty ratio measurement: logic impulse duty ratio refers to: $(\text{high level width}/\text{impulse cycle}) \times 100\%$
- Diode measurement: during diode measurement the meter is indicating to the forward voltage drop of the diode
- Insulation resistance measurement: during insulation resistance measurement state, press the TEST key to start measuring, and then press the TEST key again to stop measuring. The measurement range of the insulation resistance is 50k---2G.

- Maximum/minimum value measurement: by pressing MAX/MIN keys the meter can enter the maximum/minimum value record state, and it will continuously update the maximum/minimum values based on the new measurement results. Pressing the MAX/MIN key can display the maximum value, the minimum value, the average value and the current value in cycles. After exiting the MAX/MIN measurement state the recorded maximum value/minimum values will disappear.
- Automatic shutdown and the continuous operating mode: after the meter being turned on, in case of stopping to pressing any key or stopping to turning the rotary switch for more than fifteen minutes, the meter will automatically shutdown. (The meter will not automatically shutdown during the insulation resistance measurement.)As the meter will still consume a little energy after its automatic shutdown, so it is better to turn off the POWER switch if the meter remains idle for a long time. If you want the meter to operate continuously without automatically turning off, it can be done only just by pressing down the SELECT key at the same time when turning on the POWER switch.
- Low voltage detection: when the meter detecting the total voltage of the batteries lower than 6.8V, the  symbol on the LCD screen will be lighted to prompt the batteries should be replaced.

Chapter 3 Operation Methods

ACV Measurement

The measurement is shown as in Figure 3-1, with voltage range being of AC 0.5V ~ 1000V and the measurement methods being as follows:

1. Turn on the power switch and set the rotary switch to the position of \tilde{V} .
2. Insert the red and black testing lines into **V** end and **COM** end respectively.
3. Connect the meter to the two ends of the measured voltage with the red and black probes.
4. Read the meter's data from the display screen. When OL displaying on the meter, it indicates the measured voltage exceeding the meter's range and it is necessary to remove both the red and black probes from the measured circuit immediately.
5. By pressing the **RANGE** key it is possible to select range manually. Indicator of range displays range. While displaying OL during manual range measurement, it is necessary to select a larger range. When OL displaying under the maximum range, it indicates the voltage exceeding 1000V, so it is necessary to remove both the red and black probes from the measured circuit immediately.

Notes: in case of probe hanging in the air, the voltage inducted by the testing line may cause unstable readings on the display screen, but that will not affect the accuracy of measurement.

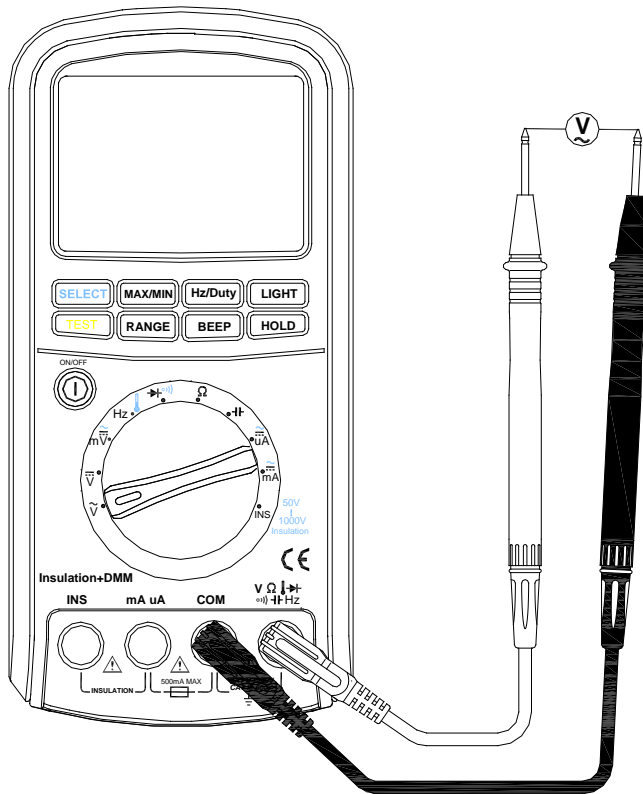

ACV Measurement



Warning

Not try to measure
a voltage higher than
1000 Volt

Figure 3-1

DCV Measurement

The measurement is shown in Figure 3-2, the range of voltage is of AC or DC 0.5V ~ 1000V and the methods are as follows:

1. Turn on the power switch and set the rotary-table switch to the position \overline{V} .
2. Insert the red testing line into the **V** end and the black testing line into the **COM** end.
3. Connect the red probe to the positive polarity of the measured voltage and the black probe to the negative polarity of the measured voltage.
4. Read the measured value from the display screen. If OL displaying on the meter, it indicates the measured voltage exceeding the range of the meter and it is necessary to remove the both red and black probes from the measured circuit immediately.
5. By pressing the **RANGE** key it is possible to select range manually. The indicator of range indicates the range value. If OL displaying during manual range measurement, it is necessary to select a larger range. If OL displaying under the maximum range, it indicates the voltage exceeding 1000V and it is necessary to remove the both red and black probes from the measured circuit immediately.

Notes: in case of probe hanging in the air, the voltage inducted by the testing line may cause unstable readings on the display screen, but that will not affect the accuracy of measurement.

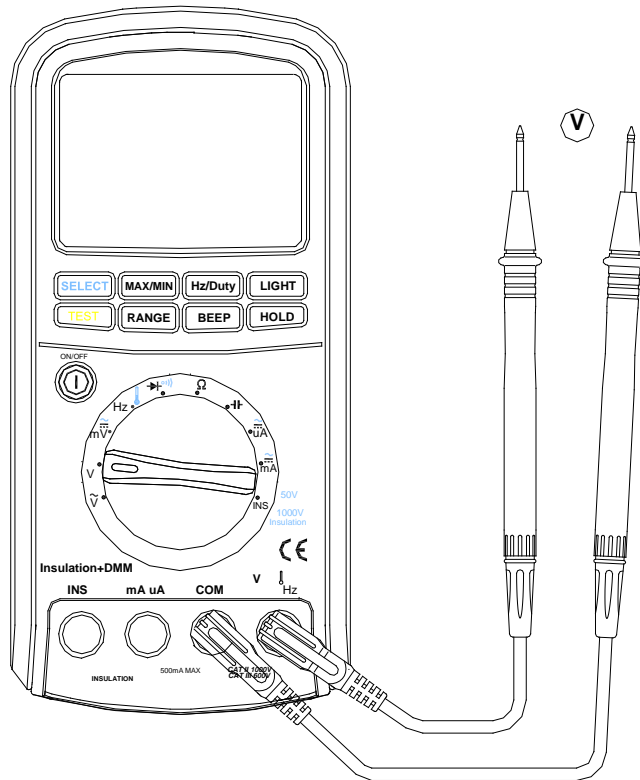

DCV Measurement



Warning

Not try to measure
a voltage higher than
1000 Volt

Figure 3-2

DC mV/AC mV Measurement

The testing chart is shown in the Figure 3-3. The voltage measurement range is of 0.01mV ~ 500mV and the measurement methods are as follows:

1. Turn on the power switch and set the rotary switch to the position $m\tilde{V}$.
2. Insert the red testing line into the **V** end and the black testing line into the **COM** end.
3. Press the **SELECT** key to select **DCmV** or **Ac mV** measurement modes.
4. When performing DCmV measurement, connect the red probe to the positive polarity of the measured voltage and the black probe to its negative polarity. While performing ACmV measurement, it will be done by connecting the red probe and the black probe into the two ends of the measured voltage.
5. Read the measured value from the display screen. If OL displaying on the meter, it indicates the measured voltage exceeding the range of the meter and it is necessary to remove both the red and black probes from the measured circuit immediately.
6. When performing DCmV or ACmV measurement, by pressing the **RANGE** key it is possible to select range manually. The indicator of range indicates the range value. If OL displaying during manual range measurement, it is necessary to select a larger range. If OL displaying under the maximum range, it is necessary to remove both the red and black probes from the measured circuit immediately.

Notes: In case of probe hanging in the air, the voltage inducted by the testing line may cause unstable readings on the display screen, but that will not affect the accuracy of measurement.

DC mV/AC mV Measurement

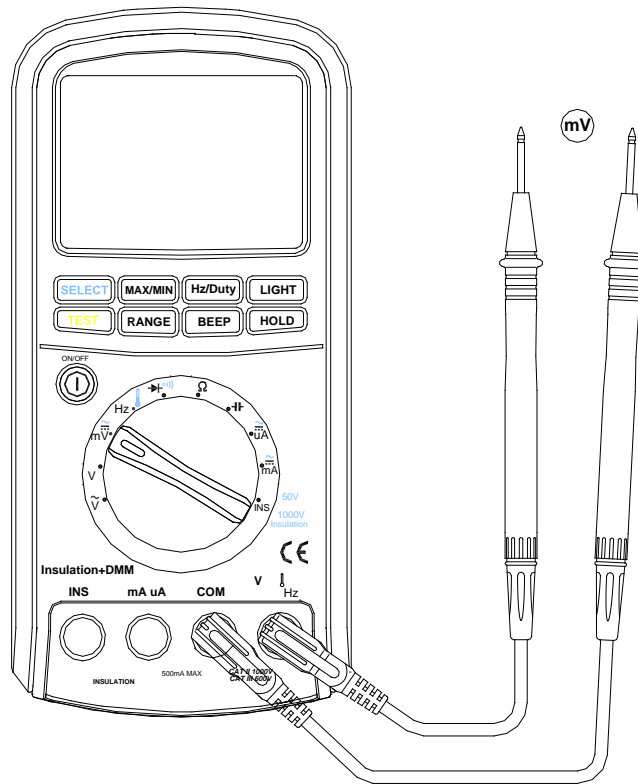

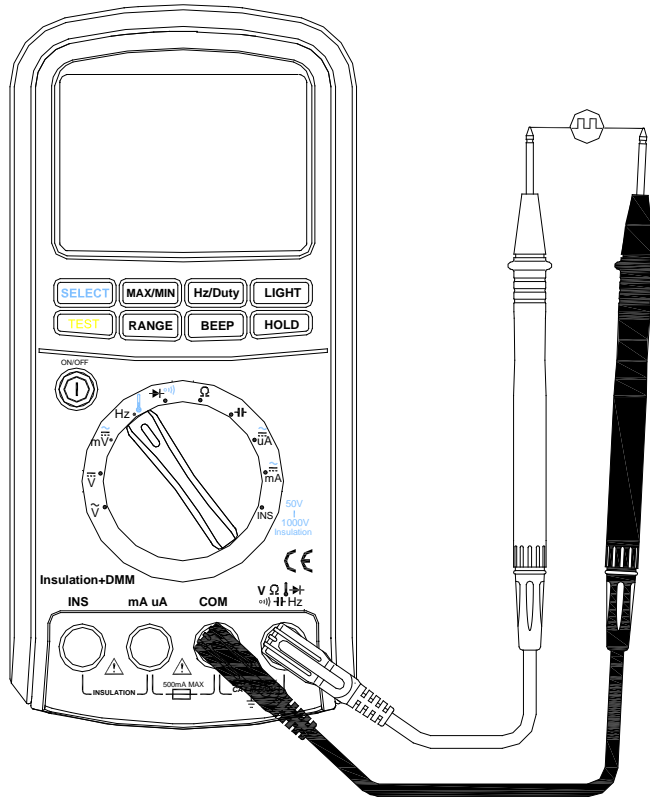

Figure 3-3

Impulse Frequency/Duty Ratio/Temperature Measurement

The testing chart is shown in the Figure 3-4. When performing impulse frequency and duty ratio measurement, the frequency range is of 5Hz ~ 2MHz (V_p 2.5 ~ 5V), while the duty ratio measurement range being of 5% ~ 95%. When performing temperature measurement, the temperature range is of -40°C ~ 537°C . And the measurement methods are as follows:

1. Turn on the power switch and set the rotary switch to the position **Hz** .
2. When performing impulse frequency and duty ratio measurement, insert the red testing line into the **VΩHz** end and the black testing line into the **COM** end. When performing temperature measurement, insert the positive polarity of the thermocouple into the **V** end and the negative polarity into the **COM** end.
3. Press the **Hz/Duty** key to select the logic frequency (Hz) or duty ratio ($\square\%$) modes.
4. When performing impulse frequency and duty ratio measurement, connect the red testing line to high logic level, the black one to low logic level.
5. Read the measured value from the display screen. If the frequency of the measured signal is lower or higher than the meter's measurement range, the reading will be displayed as zero. If the amplitude of signal is too low or the low level is larger than 1 volt, the reading will also displayed as zero.
6. The impulse frequency and duty ratio measurement is of automatic range, it is null to press the **RANGE** key.
7. Press the **SELECT** key to select the temperature measurement mode.
8. When performing temperature measurement, if the meter's input end is no-load in the air, the 'OPEN' symbol will be displayed. Insert the positive polarity of the thermocouple into the **V** end and the negative polarity into the **COM** end, read the measured value from the display screen. If the measured temperature is higher than the meter's measurement range, it will display the internal environment temperature and the 'OL' symbol will be displayed.
9. Press the **RANGE** key to select Celsius or Fahrenheit.



Logic Frequency

Duty Ratio

Temperature



Measurement

Figure 3-4

Diode/continuity Measurement

The measurement chart is shown in figure 3-5. The measurement range of diode is of 0 ~ 2.5V.

The measurement methods are as follows:

1. Turn on the power switch and set the rotary switch to the position  .
2. Insert the red testing line into the **V** end and the black testing line into the **COM** end.
3. Press the **SELECT** key to select diode () or the continuity () modes.
4. For the diode measurement, connect the red probe to the positive polarity of the diode and the black probe to its negative polarity, while the display screen will display the forward voltage drop.
5. Connect the black probe to the positive polarity of the diode and the red probe to its negative polarity, if OL displaying on the display screen, it indicates the backward resistance of the diode being normal, while OL not displaying, it indicates that the diode is backward leaking.
6. For the continuity measurement, if the measurement result is less than 25Ω and the buzzer is permitted to sound, the buzzer will sound.

Notes: In case of performing diode or continuity test on circuit board, it is necessary firstly to turn off the power of the circuit board and then perform the measurement. As there may be other parallel circuits, so there will be the difference between the displayed values of test.

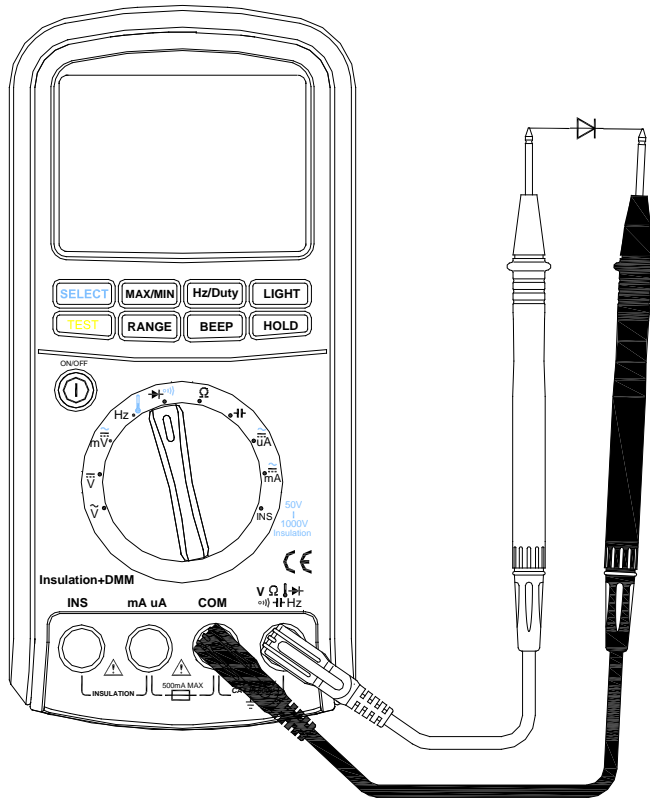

**Diode
continuity
Measurement**

Figure 3-5

Resistance Measurement

The Measurement chart is seen in Figure 3-6. The measurement range of resistance is of $0.1\Omega \sim 50M\Omega$ and the measurement methods are as follows:

1. Turn on the power switch and set the rotary switch to the position  .
2. Insert the red and black testing lines into the **V** input end and the **COM** input end respectively.
3. Connect the red and black probes to the two ends of resistor and read the resistance value from the display screen. If OL displaying, it indicates the resistor is larger than $50M\Omega$.
4. When the resistance measurement mode being implemented, it is possible to select range by pressing the **RANGE** key. The indicator of range indicates the value of range. If OL displaying during manual range measurement, it is necessary to select a larger range.

Notes: In case of performing resistance test on circuit board, it is necessary firstly to turn off the power of the circuit board and then perform the measurement. As there may be other parallel circuits, so the displayed value of test is not surely the actual value of the resistor.

Resistance Measurement

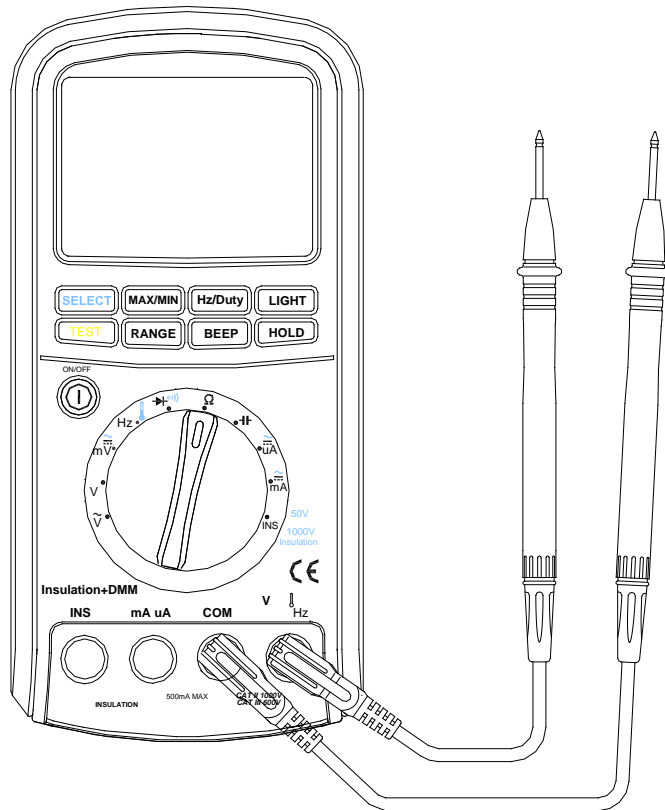



Figure 3-6

Capacitance Measurement

The measurement chart is seen in figure 3-7. the measurement range of capacitance is of

0.1nF ~ 1000μF and the measurement methods are as follows:

1. Turn on the power switch and set the rotary switch to the position  .
2. Insert the red and black testing lines into the **V** input end and the **COM** input end respectively.
3. If exists voltage in the capacitor, connect the two ends of the capacitor for a short time to discharge.
4. Connect the red and black probes to the two ends of the capacitor, if the measured capacitor is heteropolar, it is necessary to connect the red probe to the positive polarity of the capacitor and the black probe to its negative polarity.
5. Read the capacitance from the display screen. If capacitance value >1000μF, the meter will display OL, while capacitance value <0.1nF, it will display zero.
6. It is possible to select range manually by pressing the **RANGE** key. The indicator of range indicates the value of range. If OL displaying during manual range measurement, it is necessary to select a larger range. If it has been the largest range, which means capacitance value >1300μF.

Notes: When performing measurement on **500μF-1000μF** capacitor, in order to ensure measurement accuracy the meter takes a relative long time to discharge capacitor, so it is relatively slow in refreshing the measured value. In addition, not to perform Capacitance measurement on a circuit board on which there are other parallel devices, for that may leads to very large error.

The measurement results may be related to the quality of capacitance.

Capacitance Measurement

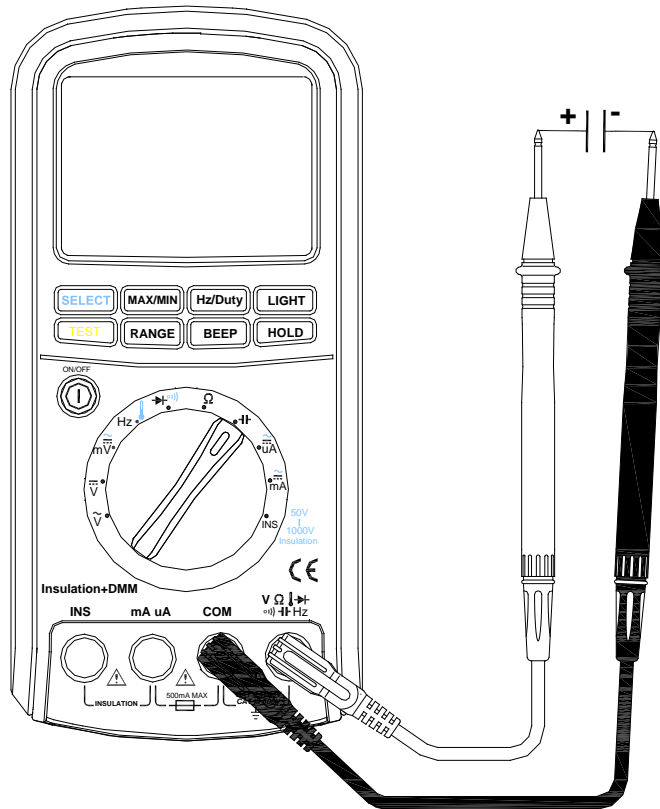
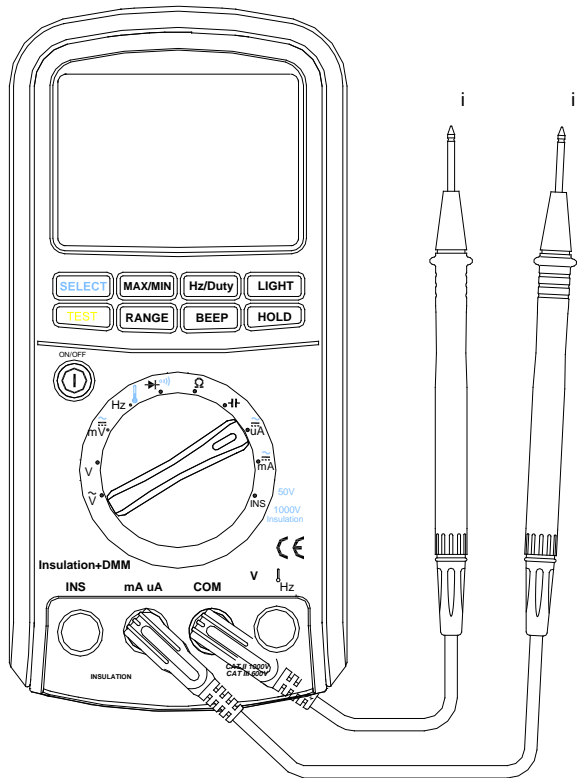

Figure 3-7

DC μA /AC μA Measurement

The measurement is seen in Figure 3-8, the measurement range of current is of AC or DC $0.1\mu\text{A} \sim 5000\mu\text{A}$, and the measurement methods are as follows:

1. Turn on the power switch and set the rotary switch to the position $\bullet \overset{\sim}{\mu\text{A}}$.
2. Insert the red testing line into the **mA/ μA** input end and the black testing line into the **COM** input end.
3. Press the **SELECT** key to select the **DC μA or AC μA** measurement modes.
4. Turn off the power of the measured circuit, connect the red and black probes to the measured circuit in serial way and then turn on the power of the measured circuit.
5. Read the measured value from the display screen. If it displays as positive during the DC measurement, it means the current is flowing into the meter from the red testing line, while it displaying as negative, it means the current is flowing into the meter from the black testing line. If it displays as OL, it means current exceeding range.
6. During measurement of **DC μA or AC μA** , it is possible to select range manually by pressing the **RANGE** key.



DC μ A

AC μ A

Measurement

Figure 3-8

DC mA/AC mA Measurements

The measurement is seen in the Figure 3-9. The measurement range of current is of AC or DC 0.01mA ~ 500mA and the measurement methods are as follows:

1. Turn on the power switch and set the rotary switch to the position $\overset{\sim}{\text{mA}}$.
2. Insert the red testing line into the **mA/μA** input end and the black testing line into the **COM** input end.
3. Press the **SELECT** key to select the **DC mA or AC mA** measurement modes.
4. Turn off the power of the measured circuit, connect the red and black probes to the measured circuit in a serial way and then turn on the power of the measured circuit again.
5. Read the measured value from the display screen. If it displays as positive during DC measurement, it means the current is flowing into the meter from the red testing line, while it displays as negative, it means the current is flowing into the meter from the black testing line. If it displays OL, indicating current exceeding range.
6. When performing **DC mA or AC mA** measurement, it is possible to select range manually by pressing the **RANGE** key.

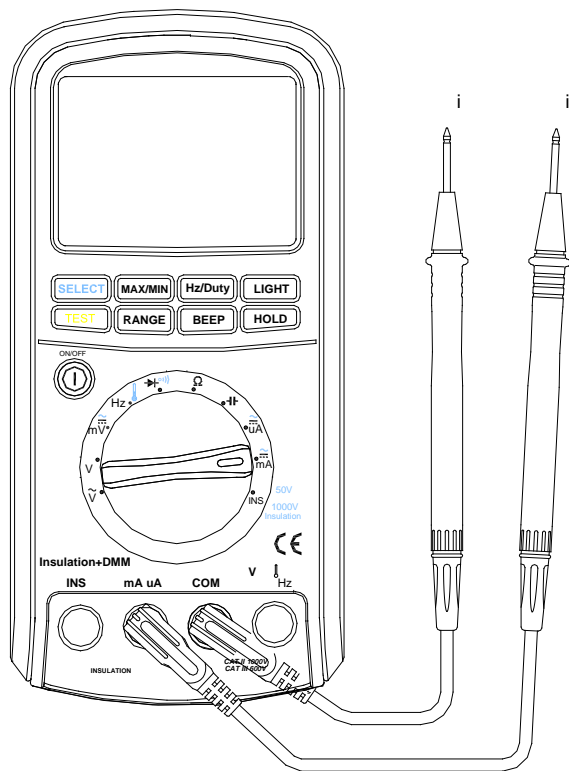

DC mA

AC mA

Measurement

Figure 3-9

Insulation Resistance Measurement

The measurement is seen in Figure 3-10, the measurement range of the insulation resistance is 50k---2G and the measurement methods are as follows:

1. Turn on the power switch and set the rotary switch to the position **INS**.
2. Insert the black testing line into the **mA/μA** input end and the red testing line into the insulation test end.
3. Connect the red probe and the black probe into the two ends of the measured insulator. Press the RANGE key to select a suitable test voltage range(The measurement range of the insulation resistance corresponding to each range of the measurement voltage are as follows: 50V---10k~50M, 100V---10k~100M, 250V---100k~250M, 500V---100k~500M, 1000V---100k~2G). When performing the insulation resistance measurement, it has not the function of auto-range.
4. Press the **TEST** key to start measuring. If the measured insulation resistance is lower than the meter's measurement range, it will stop measuring automatically. Pressing the **TEST** key again during the measurement will also stop measuring.
5. When performing the insulation resistance measurement, it has not the function of automatic shutdown.

Note: It will take the initiative to generate high voltage under this function. Please be sure to pay attention when used.

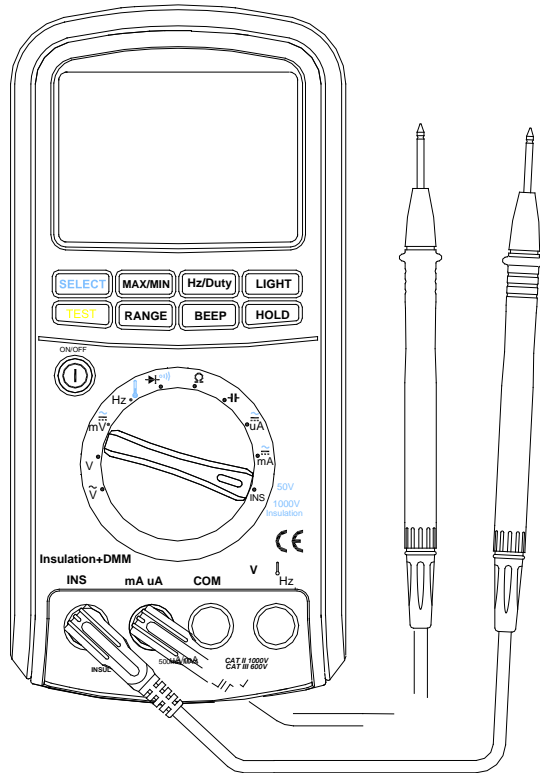

Insulation Resistance Measurement

It will take the initiative to generate high voltage under this function. Please be sure to pay attention when used.

Figure 3-10

Linear Frequency Measurement

The measurement is seen in the Figures 3-1, 3-3, 3-8 and 3-9. The measurement range is of 5Hz ~ 200kHz and the measurement methods are as follows:

1. When performing AC voltage or AC current measurement, it is possible to measure and display the alternating frequency by pressing the **Hz/Duty** key. However it has a certain requirements for the amplitude of alternating signal and the meter has varied requirements for signal amplitude when it is in different ranges, for information of which please refer to Table 3-1.
2. If the position of rotary switch is in ACV, after pressing **Hz/Duty** key the indicator of range will indicates the meter's present voltage range. In addition, it is possible to change the range by pressing the **RANGE** key to meet the different voltages.
3. Press **Hz/Duty** key again to exit linear frequency

Table 3-1

Range	Sensibility(RMS sine wave)
500mV	100mV
5V	0.4V
50V	4V
500V	40V
1000V	400V
5000 μ A	1mA
500mA	100mA

Maximum Value/Minimum Value/Average Value Measurement

By pressing the **MAX/MIN** key the meter will enter the maximum value, minimum value and average value record state . The meter measures the present value and continuously judges if it is necessary to update the maximum or minimum or average value. Pressing the **MAX/MIN** key again it is possible to select displaying the minimum value, the maximum value, the average value or the current value in cycles. Under the **MAX/MIN** measurement state, press the **MAX/MIN** key for two seconds and then release it, the meter will exit the **MAX/MIN** record state.

Backlight Control

Press the **LIGHT** key to open the backlight of the LCD screen and after ten seconds the meter will automatically turn off the backlight. It is also possible to turn off the backlight by pressing the **LIGHT** key before the ten seconds. Lighting the backlight will cause three-times higher energy consumption than the ordinary operation. So by less use of backlight, the electricity can be saved.

Data Hold

By pressing the **HOLD** key it is possible to hold the measurement value and the state at the moment of pressing the **HOLD** key. While pressing the key again data measurement will be resumed.

Automatic Shutdown and Continuous Operation Mode Selection

After turning on power, the meter will in default enter the auto-shutdown timing state. Within 15 minutes after stopping to press any key or turn the rotary switch, the meter will automatically turn off. After auto-shutdown, by pressing any key or turning the rotary switch it is possible to wake the meter to resume operation. If you want the meter operates continuously without shutdown, it will be done by pressing the **SELECT** key at the same time when turning on power.

Notes: After auto-shutdown there will still be a little electricity consumption in the meter, so it is recommended to turn off the power when the meter is to remain un-working for a long time.

Chapter 4 Technological Specifications

General Features

- Voltage between the measurement end and ground is of 1000VAC/DC. 1000V CAT III, 2th pollution grade.
- 5000 counts, automatic/manual range, basic sampling rate 2.5 t/s and 51 segment analog bar.
- When rotary switch being in the positions of mV, logic frequency, diode, resistance and capacitance, the maximum overload protection voltage will be 250V (effective value), while in the positions of $\mu\text{A}/\text{mA}$ the protection current being 0.64A, and in the position of A.
- Over range indication OL.
- When the total voltage of batteries being lower than 6.8V, the symbol for battery display will be lighted.
- Fuse being 0.63A/600V ($\mu\text{A}/\text{mA}$ end).
- Six 7# AAA batteries X 6.
- Operating temperature: $0^{\circ}\text{C} \sim 30^{\circ}\text{C}$ (relative humidity $0 \sim 80\%$)
 $31^{\circ}\text{C} \sim 51^{\circ}\text{C}$ (relative humidity $0 \sim 50\%$)
- Storage temperature: $-20^{\circ}\text{C} \sim 60^{\circ}\text{C}$ (relative humidity $\leq 80\%$)
- Altitude: operation less than 2000m,
 storage less than 10000m
- Volume : 200mm X 100mm X 40mm
- Weight : 560g

Range and Accuracy

The below-listed accuracies under different ranges refer to those which are guaranteed by the meter within one-year calibration, with normal use under the operating temperature of 18°C-28°C and relative humidity less than 80%.The presentation for accuracy is: \pm (**% reading digits + number of lower digits)

- **AC Voltage**

Range	Resolution	Accuracy
		40Hz~400Hz
500mV	0.1mV	$\pm(0.8\% +4)$
5V	1mV	$\pm(0.8\% +4)$
50V	10mV	$\pm(0.8\% +4)$
500V	0.1V	$\pm(0.8\% +4)$
1000V	1V	$\pm(1.0\% +4)$

Notes: above accuracies can be guaranteed within 10%-100% of the full range.

- **DC Voltage**

Range	Resolution	Accuracy
500mV	0.1mV	$\pm(0.1\% +2)$
5V	1mV	$\pm(0.1\% +2)$
50V	10mV	$\pm(0.1\% +2)$
500V	0.1V	$\pm(0.1\% +2)$
1000V	1V	$\pm(0.1\% +2)$

Notes: above accuracies can be guaranteed within the full range

- **AC Current**

Range	Resolution	Accuracy	Voltage Drop
		40Hz~400Hz	
500 μ A	0.1 μ A	$\pm(0.8\% +4)$	102 μ V/ μ A
5000 μ A	1 μ A	$\pm(0.8\% +4)$	
50mA	10 μ A	$\pm(0.8\% +4)$	1.5mV/mA
500mA	0.1mA	$\pm(0.8\% +4)$	

Notes: above accuracies can be guaranteed within 10%-100% of the full range

- **DC Current**

Range	Resolution	Accuracy	Voltage Drop
500 μ A	0.1 μ A	$\pm(0.2\% +2)$	102 μ V/ μ A
5000 μ A	1 μ A	$\pm(0.2\% +2)$	
50mA	10 μ A	$\pm(0.2\% +2)$	1.5mV/mA
500mA	0.1mA	$\pm(0.2\% +2)$	

Notes: above accuracies can be guaranteed within the full range

- **Resistance**

Range	Resolution	Accuracy
500 Ω	0.1 Ω	$\pm(0.3\% +5)$
5k Ω	1 Ω	$\pm(0.3\% +5)$
50k Ω	10 Ω	$\pm(0.3\% +5)$
500k Ω	100 Ω	$\pm(0.3\% +5)$
5M Ω	1k Ω	$\pm(0.3\% +5)$
50M Ω	10k Ω	$\pm(0.8\% +5)$

Notes: above accuracies can be guaranteed within the full range

- **Capacitance**

Range	Resolution	Accuracy
50nF	0.01nF	±(2.5% +10)
500nF	0.1nF	±(2.5% +10)
5μF	1nF	±(2% +10)
50μF	10nF	±(2% +10)
500μF	0.1μF	±(2% +10)
1000μF	1μF	±(3% +10)

Notes: above accuracies for film capacitor or better can be guaranteed within the full range.

- **Diode**

Range	Resolution	Accuracy
2.5V	1mV	±(1%+5)

Notes: the test current is about 0.7mA

- **Logic Frequency**

Frequency Range	Sensitivity	Resolution	Accuracy
5Hz ~ 2MHz	V _p 2 ~ 5V square wave	0.001Hz	±4counts

-

Temperature

Frequency Range	Resolution	Accuracy
-40°C ~ 537°C	0.1°C	±(1% +1.5°C)

- Linear Frequency**

Frequency Range	Voltage/Current Range	Sensitivity	Resolution	Accuracy
5Hz ~ 200kHz (sine wave)	500mV	200mV	0.001Hz	±4counts
	5V	0.5V		
	50V	4V		
	500V	40V		
	1000V	400V		
	5000μA	1mA		
	500mA	100mA		

Notes: Low voltage or low frequency would lower the accuracy.

- Duty Ratio**

Frequency Range	Duty Ratio Range	Resolution	Accuracy
5Hz ~ 500kHz	5% ~ 95%	0.01%	±0.02%

- Insulation Resistance**

Excitation voltage	Resistance Range	Resolution	Accuracy
50V	50k~10M	0.01MΩ	±(3% +5)
	10M~50M	0.1 MΩ	
100V	100k~10M	0.01MΩ	±(3% +5)
	10M~100M	0.1 MΩ	
250V	250k~100M	0.1MΩ	±(1.5% +5)
	100M~250M	1MΩ	
500V	500k~100M	0.1MΩ	±(1.5% +5)
	100M~500M	1MΩ	
1000V	1M~100M	0.1MΩ	±(1.5% +5)
	100M~2G	1 MΩ	

Chapter 5 Maintenance

Replacement of Batteries

If symbol  appears on the LCD screen during measurement, it indicates the total voltage of batteries being lower than 6.8V. For ensuring measurement accuracy, it is necessary to replace the batteries. Before the replacement, must take off the red and black testing lines from the measured circuit and turn off the power of the meter. Loose the fixing screws of the cover by a standard screwdriver, then remove the cover to take out all the old batteries, replacing them with the 7# batteries. Take care to put in the batteries as the polarity specified on the shell of the meter. Put the cover as its origin. The meter must not be used until the cover of batteries being put properly and locked in.

Replacement of Fuse

It must take off the red and black testing lines from the measured circuit and turn off the power of the meter before replacement of fuse. It should only use fuse of the same model and the same electric specifications. And the meter must not be used until the cover of fuses being put properly and locked in.

Notes: generally, fuses will not be blown under the normal use of the meter. In case of blowing it is necessary first to find out the reasons for the blowing and then take an account on the use of the meter. Generally, blowing may attribute to:

- Perform voltage measurement under the current measurement state.
- Current exceeds range.

Meter Calibration

There is no any component which can be used for calibration in the meter, calibration of the meter is implemented depending on the built-in software in the meter. Professionals and accuracy-even-higher standard signal sources are required for calibration of the meter. Users possessing such conditions may contact us for calibration methods when there is a need on calibration meter, while those who having not such conditions can contact us for calibration matters.

Others

- In case of any default being found this meter must not be used continuously.
- When the meter needs repair, please send it to experienced professionals or the appointed maintenance department for repairing.
- It should use soft cloth but not organic solvents which have corrosive and dissolving effect on the shell of meter to clean the meter, and it should guard against water dropping into the meter.