

**RIGOL**

**Quick Guide**

**DS4000 Series Digital Oscilloscope**

**Sept. 2011**

**RIGOL Technologies, Inc.**



# Guaranty and Declaration

## Copyright

© 2011 RIGOL Technologies, Inc. All Rights Reserved.

## Trademark Information

**RIGOL** is a registered trademark of **RIGOL** Technologies, Inc.

## Publication Number

QGA10100-1110

## Notices

- **RIGOL** products are protected by patent law in and outside of P.R.C.
- **RIGOL** reserves the right to modify or change parts of or all the specifications and pricing policies at company's sole decision.
- Information in this publication replaces all previously corresponding materials.
- **RIGOL** shall not be liable for losses caused by either incidental or consequential in connection with the furnishing, use or performance of this manual as well as any information contained.
- Any part of this document is forbidden to be copied or photocopied or rearranged without prior written approval of **RIGOL**.

## Product Certification

**RIGOL** guarantees this product conforms to the national and industrial standards in China. International standard conformance certification is in progress.

## Contact Us

If you have any problem or requirement when using our products, please contact **RIGOL** Technologies, Inc. or your local distributors, or visit: [www.rigol.com](http://www.rigol.com).

# Safety Requirement

## General Safety Summary

Please review the following safety precautions carefully before putting the instrument into operation so as to avoid any personal injuries or damages to the instrument and any product connected to it. To prevent potential hazards, please use the instrument as specified in this manual.

### **Use Proper Power Cord.**

Only use power cords designed for the instrument and authorized by local country.

### **Ground The Instrument.**

The instrument is grounded through the Protective Earth lead of the power cord. To avoid electric shock, make sure that the earth terminal of the power cord is properly connected to the Protective Earth lead before connecting any of the input or output terminals of this instrument.

### **Connect The Probe Properly.**

The earth lead of the probe should be equal to the earth potential. Please do not connect the earth lead to high voltage.

### **Observe All Terminal Ratings.**

To avoid fire or shock hazard, observe all ratings and markers on the instrument and check your manual for detailed information about ratings before connecting the instrument.

### **Use Proper Overvoltage Protection.**

Make sure that no overvoltage (such as that caused by thunderbolt) can reach the product, or else the operator might expose to danger of electric shock.

### **Do Not Operate Without Covers.**

Do not operate the instrument with covers or panels removed.

### **Change The Power Fuse.**

If the power fuse needs to be changed, please return the instrument back to our factory and the **RIGOL** authorized operator will change it for you.

**Avoid Circuit or Wire Exposure.**

Do not touch exposed junctions and components when the unit is powered.

**Do Not Operate With Suspected Failures.**

If you suspect damage occurs to the instrument, have it inspected by qualified service personnel before further operations. Any maintenance, adjustment or replacement of components must be performed by **RIGOL** authorized personnel.

**Keep Proper Ventilation.**

Inadequate ventilation may cause temperature increase which would damage the instrument. So please keep the instrument well ventilated during operation and inspect the intake and fan regularly.

**Do Not Operate In Wet Conditions.**

In order to avoid short circuit inside the instrument or electric shock, please do not operate in humid environment.

**Do Not Operate in Flammable and Explosive Environment.**

In order to avoid damages to the device or personal injuries, please do not operate in flammable and explosive environment.

**Keep Product Surfaces Clean and Dry.**

To avoid the influence of dust and/or moisture in the air on the performance of the instrument, please keep the surface of the instrument clean and dry.

**Protect The Instrument from Static Electricity.**

Operate in a static-free area to avoid damages caused by static electricity. Ground both the internal and external conductors of the cable to discharge static electricity before connecting it to the instrument.

**Handling Safety**

Please handle with care during transportation to avoid slipping of the instrument and damages to buttons, knob, interfaces or other parts on the panels.

## Safety Terms and Symbols

**Terms in this Manual.** The following terms may appear in this manual:



---

**WARNING**

Warning statements indicate the conditions or practices that could result in injuries or loss of life.

---



---

**CAUTION**

Caution statements indicate the conditions or practices that could result in damage to this product or loss of data.

---

**Terms on the Product.** The following terms may appear on the product:

**DANGER** indicates a hazard may immediately happen.

**WARNING** indicates potential hazard may happen.

**CAUTION** indicates damage to the instrument or other devices connected to the instrument may happen.

**Symbols on the Product.** The following symbols may appear on the product:



**High Voltage**



**Refer to Manual**



**Protective Earth Terminal**



**Chassis Ground Terminal**



**Test Ground Terminal**

# Measurement Category

## Measurement Category

DS4000 series digital oscilloscopes can make measurements in Measurement Category I.



---

**WARNING**

This oscilloscope can only be used for measurements within its specified measurement categories.

---

## Measurement Category Definitions

Measurement category I is for measurements performed on circuits not directly connected to MAINS. Examples are measurements on circuits not derived from MAINS, and specially protected (internal) MAINS derived circuits. In the latter case, transient stresses are variable; for that reason, the transient withstand capability of the equipment is made known to the user.

Measurement category II is for measurements performed on circuits directly connected to the low voltage installation. Examples are measurements on household appliances, portable tools and similar equipment.

Measurement category III is for measurements performed in the building installation. Examples are measurements on distribution boards, circuit-breakers, wiring, including cables, bus-bars, junction boxes, switches, socket-outlets in the fixed installation, and equipment for industrial use and some other equipment, for example. Stationary motors with permanent connection to the fixed installation.

Measurement category IV is for measurements performed at the source of the low-voltage installation. Examples are electricity meters and measurements on primary overcurrent protection devices and ripple control units.

## Ventilation Requirement

This oscilloscope uses fan to force cooling. Please make sure that the air intake and exhaust areas are free from obstructions and have free air. When using the oscilloscope in a rack, provide at least 10 cm clearance beside, above and behind the instrument for adequate ventilation.



---

### **WARNING**

Inadequate ventilation may cause temperature increase which would damage the instrument. So please keep the instrument well ventilated during operation and inspect the intake and fan regularly.

---



---

## Working Environment

### Temperature

Operating: 0°C to +50°C

Non-operating: -20°C to +70°C

### Humidity

Under +35°C: ≤90% relative humidity

+35°C to +40°C: ≤60% relative humidity



#### **WARNING**

To avoid short circuit inside the instrument or electric shock, please do not operate in humid environment.

---

### Altitude

Operating: less than 3 km

Non-operating: less than 15 km

### Installation (overvoltage) Category

This product is powered by MAINS conforming to installation (overvoltage) category II.



#### **WARNING**

Make sure that no overvoltage (such as that caused by thunderbolt) can reach the product, or else the operator might expose to danger of electric shock.

---

### Installation (overvoltage) Category Definitions

Installation (overvoltage) category I refers to signal level which is applicable to equipment measurement terminals connected to the source circuit. In these terminals, precautions are done to limit the transient voltage to the corresponding low level.

Installation (overvoltage) category II refers to the local power distribution level which is applicable to equipment connected to the AC line (AC power).

## **Pollution Degree**

Degree 2

### **Pollution Degree Definitions**

Pollution degree 1: No pollution or only dry, non-conductive pollution occurs. The pollution has no influence. For example: a clean room or air-conditioned office environment.

Pollution degree 2: Normally only dry, non-conductive pollution occurs. Occasionally a temporary conductivity caused by condensation may occur. For example: general indoor environment.

Pollution degree 3: Conductive pollution occurs, or dry, non-conductive pollution occurs which becomes conductive due to condensation which is expected. For example: Sheltered outdoor environment.

Pollution degree 4: Pollution that generates persistent conductivity through conductive dust, rain, or snow. For example: outdoor locations.

### **Safety Class**

Class 1 – Grounded Product

---

## General Care and Cleaning

### General Care

Do not leave the instrument exposed to direct sunlight for long period of time.

### Cleaning

Clean the instrument regularly according to its use condition. To clean the oscilloscope:

1. Disconnect the instrument from power.
2. Clean the floating dust on the exterior of the instrument with a wet, drip-free and soft cloth (could use mild detergent or clear water). When cleaning an instrument with LCD, take care to avoid scratching the protective screen.

**CAUTION**

To avoid damages to the instrument, do not expose it to corrosive liquids.

---

**WARNING**

To avoid short circuit or even personal injury resulting from moisture content, make sure the instrument is completely dry before reconnecting it to a power source.

---

## Environmental Considerations

The following symbol indicates that this product complies with the requirements of European Union according to Directives 2002/96/EC on waste electrical and electronic equipment (WEEE).



### **Instrument Recycle**

Some substances contained in this product might be harmful to the environment or human health. To avoid the harmful substances being released into the environment or harming human health, we encourage you to recycle this product in an appropriate way to make sure that most of the materials are reused or recycled appropriately. Please contact your local authorities for disposal or recycle information.

# Contents

<b>Guaranty and Declaration .....</b>	<b>I</b>
<b>Safety Requirement .....</b>	<b>II</b>
General Safety Summary .....	II
Safety Terms and Symbols .....	IV
Measurement Category .....	V
Ventilation Requirement .....	VI
Working Environment .....	VII
General Care and Cleaning .....	IX
Environmental Considerations .....	X
<b>Quick Start.....</b>	<b>1</b>
General Inspection .....	1
Appearance and Dimensions.....	2
To Prepare for Operation.....	3
To Remove the Cover .....	3
To Adjust the Supporting Legs.....	4
To Connect to AC Power Supply.....	5
Power-on Inspection .....	6
To Connect the Probe .....	7
Function Inspection.....	8
Probe Compensation .....	10
Front Panel Overview.....	11
Rear Panel Overview.....	12
Front Panel Function Overview.....	14
VERTICAL .....	14
HORIZONTAL .....	15
TRIGGER .....	16
CLEAR .....	16
AUTO.....	17
RUN/STOP .....	17
SINGLE.....	17
Knob .....	18
WaveFinder .....	18

Default ..... 19

Print..... 19

Function Keys..... 19

Record..... 20

User Interface..... 21

To Use the Security Lock..... 26

To Use the Built-in Help System..... 27

**Troubleshooting ..... 29**

# Quick Start

## General Inspection

### 1. **Inspect the shipping container for damage.**

If your shipping container appears to be damaged, keep the shipping container or cushioning material until you have inspected the contents of the shipment for completeness and have checked the oscilloscope electrically and mechanically.

If your instrument has damaged during shipping, please contact your shipper and carrier for compensation. **RIGOL** will provide no free repair or replacement.

### 2. **Inspect the instrument.**

If there is any mechanical damage or defect, or if the instrument does not pass electrical and mechanical tests, please contact your **RIGOL** sales representative.

### 3. **Check the Accessories**

Please check the accessories according to the packing lists. If the accessories are incomplete or damaged, please contact your **RIGOL** sales representative.

# Appearance and Dimensions

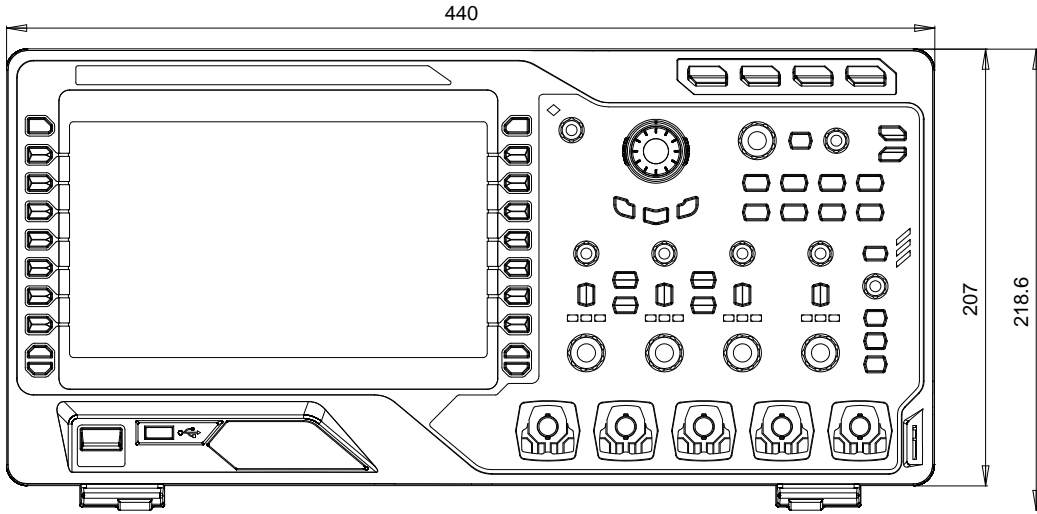

Figure 1 Front View

Unit: mm

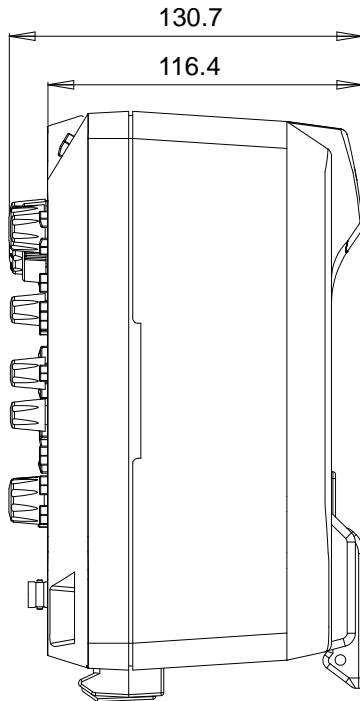

Figure 2 Side View

Unit: mm



## To Prepare for Operation

### To Remove the Cover

Before using the oscilloscope, remove the front panel cover by grasping the transverse grab on each side and pull them in the arrow directions as shown in the figure below.

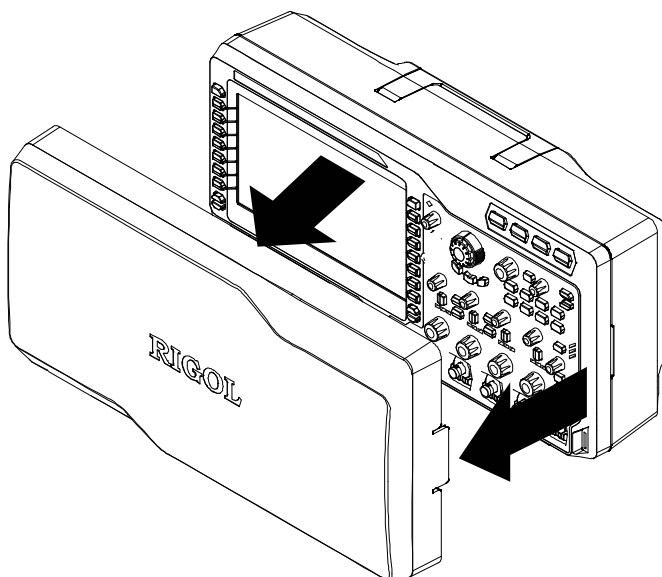

Figure 3 To Remove the Cover

## To Adjust the Supporting Legs

Adjust the supporting legs properly to use them as stands to tilt the oscilloscope upwards, thus to place the oscilloscope stably and to operate and observe the display better. You can unfold or fold the supporting legs in the arrow directions as shown in the figure below.

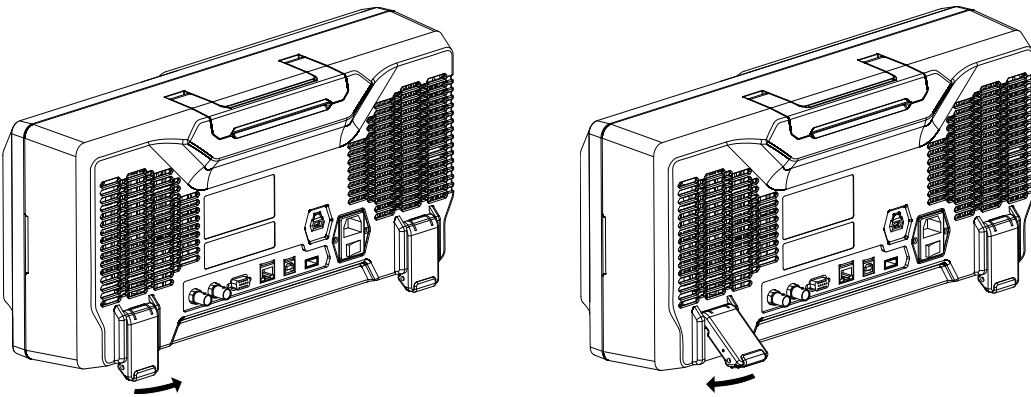



Figure 4 To Adjust the Supporting Legs

## To Connect to AC Power Supply

This oscilloscope accepts two kinds of AC power supplies: 100-127V, 45-440Hz and 100-240V, 45-65Hz. Please use the power cord supplied with the accessories to connect the oscilloscope to the power source as shown in the figure below. Turn on the power switch under the power plug; at this point, the oscilloscope is energized and the power key  at the lower-left corner of the front panel is in breath state.

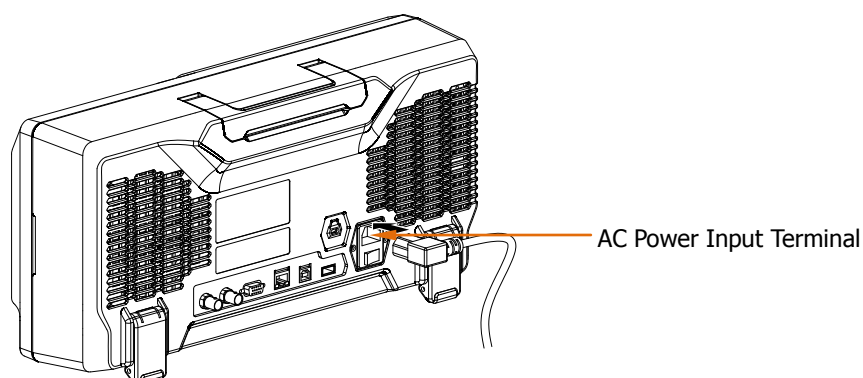



Figure 5 To Connect to AC Power Supply



### CAUTION

If the power fuse needs to be changed, please return the instrument back to our factory and the **RIGOL** authorized operator will change it for you.

## Power-on Inspection

When the oscilloscope is energized, press the power key  at the lower-left corner of the front panel to start the oscilloscope. During the start-up process, the oscilloscope performs a series of self-tests and you can hear the sound of relay switching. After the self-test, the start-up image is displayed. Press **Utility** → **System** → **SelfTestInfo** to view the self-test results.

## To Connect the Probe

**RIGOL** provides passive and active probes for the DS4000 series oscilloscopes. For detailed technical information of the probes, please refer to the corresponding Probe User's Guide. The following are the probes recommended for this oscilloscope.

Model	Description
RP3500	500 MHz, passive probe, standard, auto detection
RP7150	1.5 GHz, active probe, optional, auto detection

### Connect the Probe:

1. Connect the BNC terminal of the probe to a channel BNC connector of the oscilloscope at the front panel.
2. Connect the probe tip to the circuit point under test and connect the ground alligator clip of the probe to the circuit ground terminal.

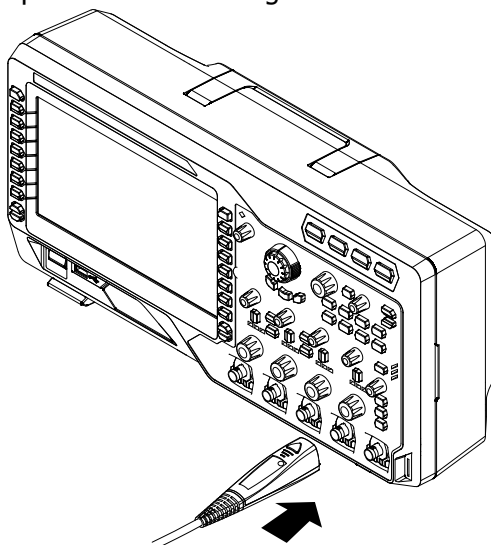

Figure 6 To Connect the Probe

## Function Inspection

1. Press **Default** to restore the oscilloscope to its default configuration.
2. Connect the BNC terminal of a probe to the BNC connector of CH1 at the front panel of the oscilloscope.
3. Connect the ground alligator clip of the probe to the "Ground Terminal" and then connect the probe tip to the "Compensation Signal Output Terminal".



Figure 7 To Use the Compensation Signal

4. Press the **AUTO** key.
5. Observe the waveform on the display. In normal condition, the display should be a square waveform as shown in the figure below:

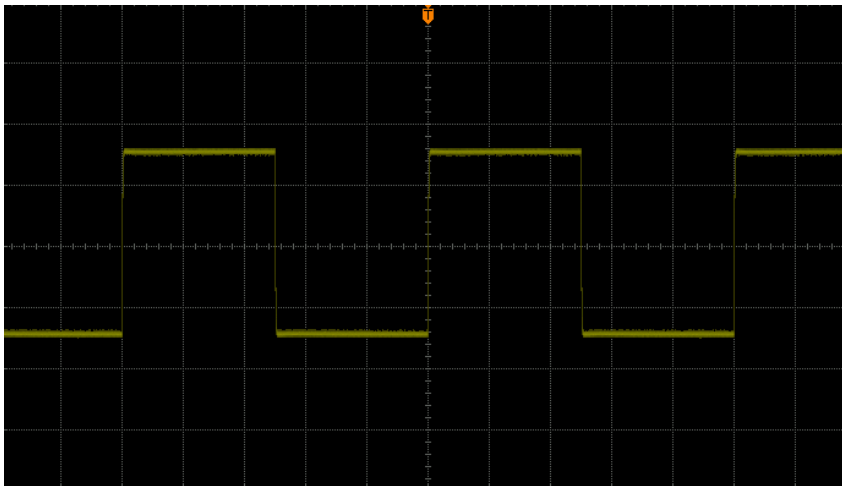

Figure 8 Square Waveform

6. Use the same method to test the other channels. If the square waveforms actually shown do not match that in the figure above, please perform **"Probe Compensation"** in the next section.

**WARNING**

To avoid electric shock during the use of probe, please make sure that the insulated wire of the probe is in good condition and do not touch the metallic part of the probe when the probe is connected to high voltage source.

**Tip**

The signal output from the probe compensation connector can only be used for probe compensation adjustment and can not be used for calibration.

## Probe Compensation

When the probes are used for the first time, you should compensate the probes to match the input channels of the oscilloscope. Non-compensated or poorly compensated probes may cause measurement inaccuracy and error. The probe compensation procedure is as follows:

1. Perform step 1, 2, 3 and 4 of "**Function Inspection**" in the previous section.
2. Check the displayed waveforms and compare them with the following figures.

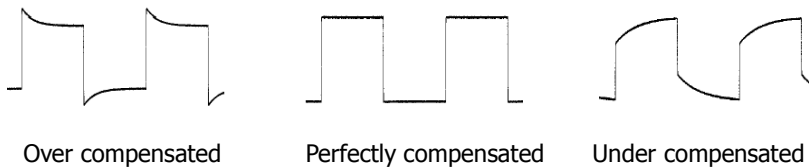

Figure 9 Probe Compensation

3. Use a nonmetallic driver to adjust the variable capacitor on the probe until the displayed waveform is as the "**Correctly compensated**" in the figure above.



## Front Panel Overview

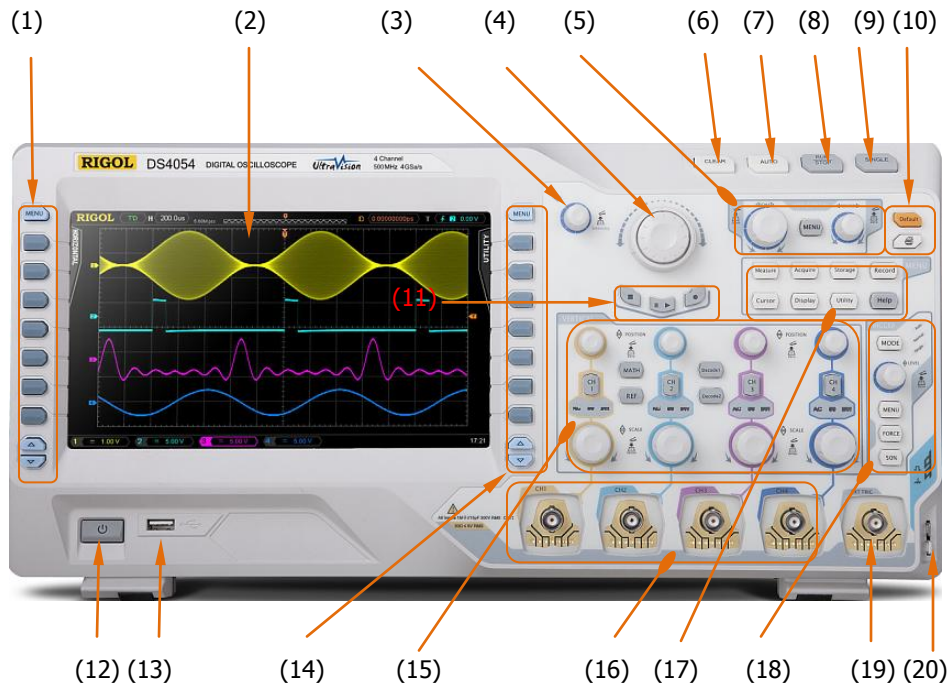

Figure 10 Front Panel Overview

Table 1 Front Panel Description

No.	Description	No.	Description
(1)	Menu	(11)	Record
(2)	LCD	(12)	Power Key
(3)	Knob	(13)	USB HOST
(4)	WaveFinder	(14)	Function Setting Menu Softkeys
(5)	HORIZONTAL	(15)	VERTICAL
(6)	CLEAR	(16)	Analog Channel Input Terminals
(7)	AUTO	(17)	Function Menu Keys
(8)	RUN/STOP	(18)	TRIGGER
(9)	SINGLE	(19)	EXT TRIG Input Terminal
(10)	Default&Print	(20)	Probe Compensation Signal Output Terminal/Ground Terminal

## Rear Panel Overview

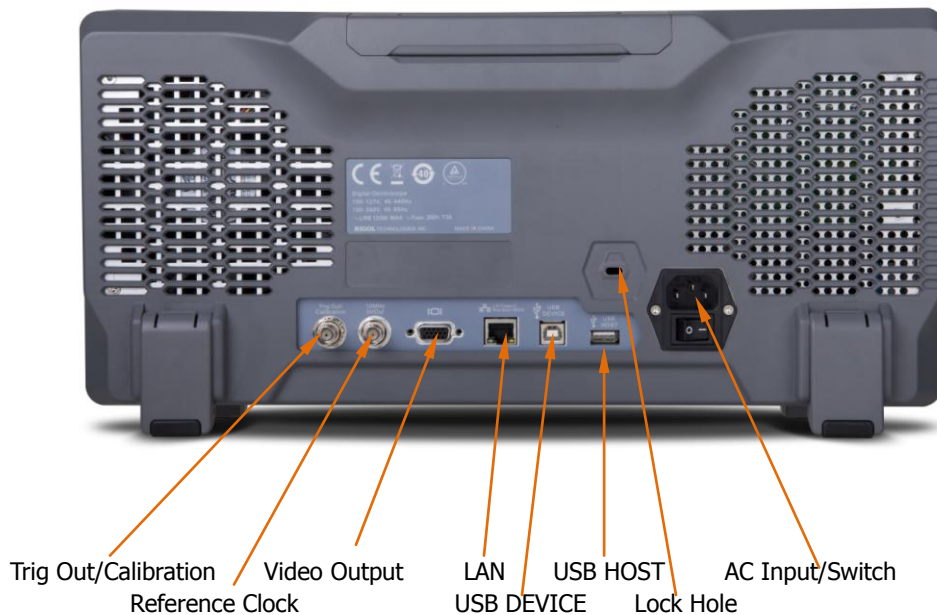

Figure 11 Rear Panel Overview

### 1. Trig Out/Calibration

Various kinds of signals can be output from this connector (press **UTIL** → **AuxOutput** to select the desired output type).

- 1) TrigOut:** the oscilloscope outputs a signal which can reflect the current capture rate of the oscilloscope each time a trigger is generated.
- 2) Fast:** the oscilloscope outputs a fast edge signal which can be used in the self-calibration of the oscilloscope.
- 3) GND:** the oscilloscope outputs a ground level.
- 4) PassFail:** the oscilloscope outputs a pulse when failed waveform is detected and the pulse is transmitted to other control system for easy view of the test result.

### 2. Reference Clock

Provide more precise sample clock signal for the oscilloscope and it can also

---

synchronize two or more oscilloscope clocks.

### **3. Video Output**

Through this interface, the oscilloscope can be connected to external monitors to get clearer waveform display. Note that the display of the oscilloscope is still valid.

### **4. LAN**

Through this interface, the oscilloscope can be connected to the network for remote control. As the oscilloscope conforms to the LXI-C instrument standard, a test system can be built quickly and accessed through webpage.

### **5. USB DEVICE**

Through this interface, the oscilloscope can be connected to PC to control the oscilloscope through PC software.

### **6. USB HOST**

Through this interface, the oscilloscope can be connected to printers to print waveform data or be connected to a USB storage device to store waveform files. RS232 interface communication can be realized by using the USB-RS232 module provided by **RIGOL**.

Note that there is also a USB HOST interface at the front panel.

### **7. Lock Hole**

Use the security lock (please buy it yourself) to lock the oscilloscope to a fixed location.

### **8. AC Input/Switch**

AC power input terminal. The power supply requirements of this oscilloscope are 100-127 V, 45-440Hz and 100-240 V, 45-440Hz; CAT II. Please connect the oscilloscope to AC power using the power cord provided with the accessories.



Then, turn on the AC power switch to energize the oscilloscope. Press the power key at the front panel to start the oscilloscope.

## Front Panel Function Overview

### VERTICAL

DS4000 provides independent vertical control systems for the four analog input channels.







- **CH1, CH2, CH3, CH4**: analog input channels. The four channels are marked by different colors which are also used to mark both the corresponding waveforms on the screen and the channel input connectors. Press any key to open the corresponding channel menu and press again to turn off the channel. AC: illuminated when AC channel coupling mode is enabled. 50: illuminated when the channel input impedance is 50Ω. BW: illuminated when bandwidth limit is enabled.
- **MATH**: press this key to open the math operation menu under which (add, subtract, multiply, divide) operations, FFT operation, logic operation and advanced operation are provided.
- **REF**: press this key to enable the reference waveform function to compare the waveform actually tested with the reference waveform to decide circuit failures.
- **VERTICAL**  **POSITION**: vertical position knobs. During the modification, the position label at the lower left corner of the screen would change accordingly. Turn clockwise to increase the position and counterclockwise to decrease. Press down the knob to quickly reset the vertical position.
- **VERTICAL**  **SCALE**: vertical scale knobs. During the modification, the scale label at the bottom of the screen would change accordingly. Turn clockwise to

decrease the scale with a step of 5-2-1 and turn counterclockwise to increase with a step of 1-2-5. Press down the knob to switch the vertical scale adjustment mode between "Coarse" and "Fine".

- **Decode1** and **Decode2**: decoding function keys. Press the corresponding key to open the decoding function menu. DS4000 supports parallel decoding and protocol decoding.

## HORIZONTAL



- **MENU**: press this key to open the horizontal control menu with which users can turn on or off the delayed sweep function, switch between different time base modes, switch between "Coarse" and "Fine" adjustments of scale as well as modify the horizontal reference setting.
- **HORIZONTAL**  **SCALE**: modify the horizontal time base. Turn clockwise to reduce the time base and turn counterclockwise to increase the time base. During the modification, waveforms of all the channels will be displayed in expanded or compressed mode and the time base message (e.g. **H** ) at the upper side of the screen would change accordingly. Press down the knob to quickly switch to delayed sweep state.
- **HORIZONTAL**  **POSITION**: modify the trigger position. The trigger point would move left or right relative to the center of the screen when you turn the knob. During the modification, waveforms of all the channels would move left or right and the trigger position message (e.g. **D** ) at the upper-right corner of the screen would change accordingly. Press down the knob to quickly reset the trigger position (or the delayed sweep position)

## TRIGGER



**MODE**: press this key to switch the trigger mode to **Auto**, **Normal** or **Single** and the state backlight of the current trigger mode would be illuminated.

**TRIGGER LEVEL**: modify the trigger level. Turn clockwise to increase the level and turn counterclockwise to reduce the level. During the modification, the trigger level line moves up and down and the value in the trigger level message box (e.g. **Trig Lvl: 284mV**) at the lower-left corner of the screen would change accordingly. Press down the knob to quickly reset the trigger level to zero point.

**MENU**: press this key to turn on the trigger operation menu. This oscilloscope provides various trigger types.

**FORCE**: in **Normal** and **Single** trigger modes, press this key to generate a trigger signal forcefully.

**50%**: press this key to set the trigger level to the vertical midpoint of the trigger signal amplitude.

## CLEAR

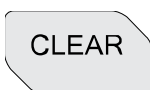

Press this key to clear all the waveforms on the screen. If the oscilloscope is in "Run" state, waveforms will still be displayed.

## AUTO

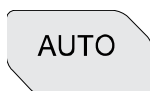

Press this key to enable the waveform auto setting function. The oscilloscope will automatically adjust the vertical scale, horizontal time base and trigger mode according to the input signal to realize optimum waveform display. Besides, quick parameter measurement function is also provided.

Note that auto setting requires that the frequency of the signal under test should be no lower than 50 Hz, the duty cycle be greater than 1% and the amplitude be at least 20 mVpp. If the parameters exceed these limits, "Auto failed" would be displayed after pressing this key and the quick parameter measurement menu might not be displayed.

## RUN/STOP



Press this key to set the state of the oscilloscope to "Run" or "Stop". In "Run" state, the key is illuminated in yellow and red in "Stop" state.

## SINGLE



Press this key to set the trigger mode to "Single". In single trigger mode, the oscilloscope triggers when the trigger condition is met and stops after capturing and displaying the data of a single trigger. At this point, **RUN/STOP** is illuminated in red.

## Knob



This knob can be used to adjust the value of the parameters, adjust the waveform brightness and select the desired menu.

- During parameter input, turn the knob clockwise to increase the parameter and counterclockwise to decrease.
- When the menu blanks off, rotate the knob to adjust the waveform brightness. The adjustable range is from 0% to 100%. Turn the knob clockwise to increase the waveform brightness and counterclockwise to decrease. Press down the knob to reset the waveform brightness to 50%. Users can also press **Display** → **Brightness** and then rotate the knob to adjust the waveform brightness.
- During menu operation, after pressing a menu softkey, rotate the knob to select the desired sub-menu under that menu.

## WaveFinder



This knob provides quick Adjust/Locate function for numerical parameters with relatively larger settable ranges. Turn the knob clockwise (counter-clockwise) to increase (reduce) the value. Note that the inner knob is used for fine adjustment and the outer knob for coarse adjustment. For example, this knob can be used to quickly locate the waveform frame ("Current Frame" menu) to be played back in waveform playback. Similar menus include trigger holdoff, pulse width setting, slope time etc.



## Default



Press this key to restore the oscilloscope to its default configuration.

## Print

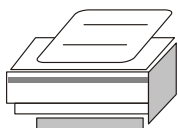

Press this key to execute print function or save the screen in the USB storage device. If the oscilloscope is currently connected to a printer and the printer is in idle state, press this key to execute print function. If no printer but a USB storage device is currently connected, press this key to save the screen to the USB storage device in “.bmp” format. When printer and USB storage device are connected at the same time, the printer enjoys higher priority.

## Function Keys



- **Measure**: press this key to enter measurement setting menu to set the measurement-related parameters.
- **Acquire**: press this key to enter sample setting menu to set the acquisition mode, the memory depth and the antialiasing function of the oscilloscope.
- **Storage**: press this key to enter file store and recall interface. The storable file types include traces, waveforms, setups, picture and CSV. This instrument supports internal and external storage as well as disk management.
- **Cursor**: press this key to enter cursor measurement menu. The oscilloscope provides three cursor modes: manual, track and auto.

- **Display**: press this key to enter display setting menu to set the display type, persistence time, brightness, grid type, grid brightness and menu display time of the waveform.
- **Utility**: press this key to enter system function setting menu to set the system-related functions or parameters, such as I/O setting, sound and language. The oscilloscope also supports some advanced functions such as pass/fail test and print setting.
- **Record**: press this key to enter waveform record menu. The oscilloscope provides waveform record function and supports record constant open mode as well as playback and analysis of recorded waveform.
- **Help**: press this key to open the help interface. For detailed information, please refer to the introduction in **"To Use the Built-in Help System"**.

## Record



Stop      Play/Pause      Record

**Play/Pause**: in stop or pause state, press this key to play the recorded or paused waveform and press again to pause the play. The backlight is illuminated in yellow.

**Stop**: press this key to stop the waveform in record or playback mode. The backlight is illuminated in orange.

**Record**: press this key to start recording the waveform. The backlight is illuminated in red. Besides, the backlight will also be illuminated when record constant open mode is enabled.

## User Interface

DS4000 oscilloscope provides 9 inches, WVGA (800\*480) 160,000 color TFT LCD. What is worth mentioning is that the 14-grid ultra-wide screen makes you view "longer" waveform.

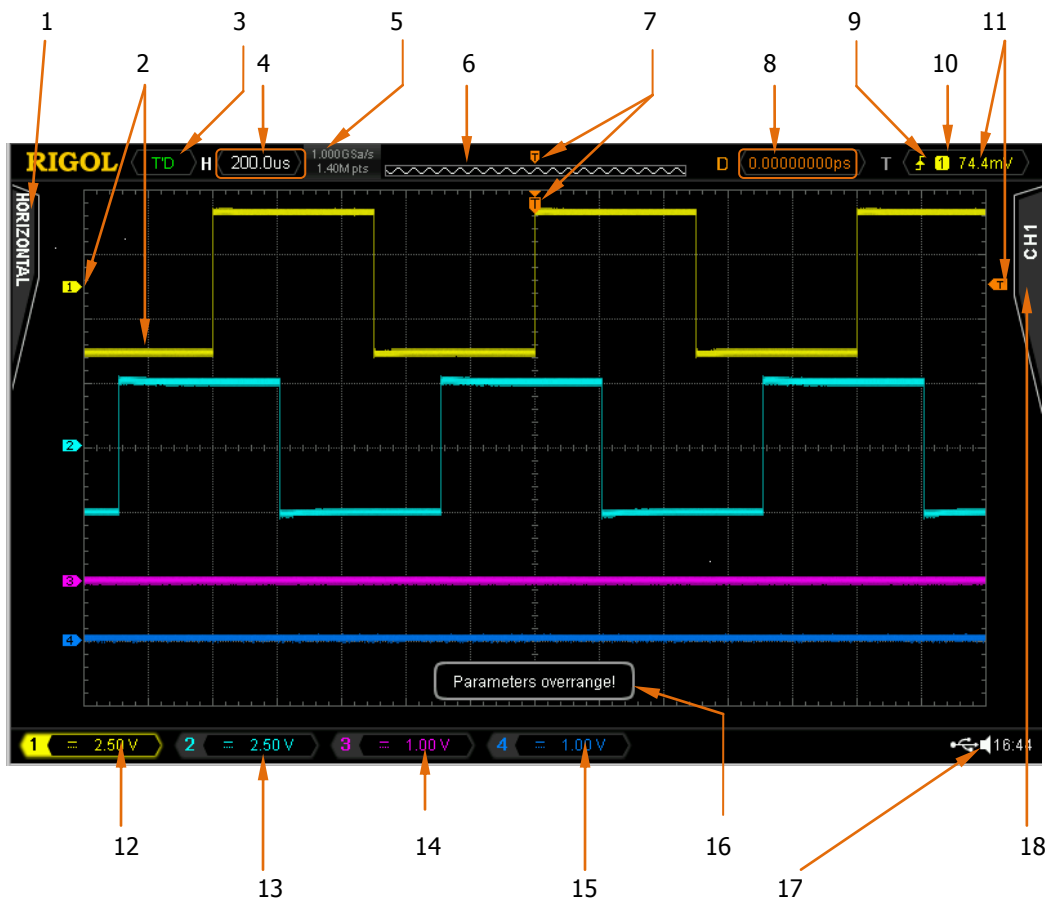

Figure 12 User Interface

## 1. Measurement Menu

Provide 12 horizontal (HORIZONTAL) and 10 vertical (VERTICAL) measurement parameters. Press the softkey at the left of the screen to activate corresponding measurement item.

## 2. Channel Label/Waveform

Different channels are marked by different colors and the color of the waveform complies with the color of the channel.

## 3. Status

Available states include RUN, STOP, T'D (triggered), WAIT and AUTO.

## 4. Horizontal Time Base

- Represent the time per grid on the horizontal axis on the screen.
- Use **HORIZONTAL**  **SCALE** to modify this parameter. The range available is from 1.000ns to 50.00 s.

## 5. Sample Rate/Memory Depth

- Display the current sample rate and memory depth of the oscilloscope.
- Use **HORIZONTAL**  **SCALE** to modify this parameter.

## 6. Waveform Memory

Provide the schematic diagram of the memory position of the waveform currently on the screen.

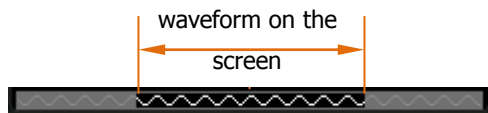

## 7. Trigger Position

Display the trigger position of the waveform.

## 8. Trigger Position

Use **HORIZONTAL**  **POSITION** to modify this parameter. Press down

the knob to automatically set the parameter to zero.

## 9. Trigger Type

Display the currently selected trigger type and trigger condition setting.

Different labels are displayed when different trigger types are selected.



For example:  represents triggering on the rising edge in "Edge" trigger.

## 10. Trigger Source

Display the trigger source (CH1-CH4, EXT, EXT/5 or AC Line) currently selected. Different labels are displayed when different trigger sources are selected and the color of the trigger parameter area will change accordingly.





For example:  denotes that CH1 is selected as the trigger source.

## 11. Trigger Level





-  at the right of the screen is the trigger level label and the trigger level value is displayed at the upper-right corner of the screen.
- When Using **TRIGGER**  **LEVEL** to modify the trigger level, the trigger level value will change with the up and down of .

Note that in slope trigger, there are two trigger level labels ( and .





## 12. CH1 Vertical Scale

- Display the voltage value per grid of CH1 waveform vertically.
- Use **VERTICAL**  **SCALE** to modify this parameter.
- The following labels will be provided according to the current channel setting: channel coupling (e.g.  in AC coupling), bandwidth limit (e.g.  when bandwidth limit is enabled) and input impedance (e.g.  when the input impedance is **50Ω**).





## 13. CH2 Vertical Scale

- Display the voltage value per grid of CH2 waveform vertically.
- Use **VERTICAL**  **SCALE** to modify this parameter.
- The following labels will be provided according to the current channel setting: channel coupling (e.g.  in AC coupling), bandwidth limit (e.g.  when bandwidth limit is enabled) and input impedance (e.g.  when the input impedance is **50Ω**).

#### 14. CH3 Vertical Scale

- Display the voltage value per grid of CH3 waveform vertically.
- Use **VIRTICAL**  **SCALE** to modify this parameter.
- The following labels will be provided according to the current channel setting: channel coupling (e.g.  in AC coupling), bandwidth limit (e.g.  when bandwidth limit is enabled) and input impedance (e.g.  when the input impedance is **50Ω**).

#### 15. CH4 Vertical Scale



- Display the voltage value per grid of CH4 waveform vertically.
- Use **VIRTICAL**  **SCALE** to modify this parameter.
- The following labels will be provided according to the current channel setting: channel coupling (e.g.  in AC coupling), bandwidth limit (e.g.  when bandwidth limit is enabled) and input impedance (e.g.  when the input impedance is **50Ω**).

#### 16. Message Box

Display prompt messages.

#### 17. Notification Area

Display system time, sound icon and USB storage device icon.



- System Time: displayed in "hh:mm (hour:minute)" format. When printing or storing the waveform, the output file will contain this time message. Press **Utility** → **System** → **System Time** to set the time in the following format:  
mm-dd-yyyy hh-mm-ss  
(month-date-year hour-minute-second)
- Sound Icon: when sound is enabled,  is displayed. Press **Utility** → **Sound** to turn the sound on or off.
- USB Storage Device Icon: when the oscilloscope detects a USB storage device,  is displayed.

#### 18. Operation Menu



Press any softkey to activate the corresponding menu. The following

symbols might be displayed in the menu:



Denote that  at the front panel can be used to select parameter items. The backlight of  turns on when parameter selection is valid.



Denote that  can be used to modify parameter value. The backlight of  turns on when parameter input is valid.



Denote that you can use the **WaveFinder** to quickly adjust/locate parameters.



Denote that users can rotate and then press down  to select the desired parameter.



Denote that the current menu has several options.



Denote that the current menu has a lower level menu.



Press this key to return to the previous menu.

Note that the following direction keys might appear in the grid at the lower-left corner of the menu bar:



Denote that you can open the next page menu.



Denote that you can open the previous page menu.

## To Use the Security Lock

If needed, you can use the security lock (please buy it yourself) to lock the oscilloscope to a fixed location. The method is as follows, align the lock with the lock hole and plug it into the lock hole vertically, turn the key clockwise to lock the oscilloscope and then pull the key out.

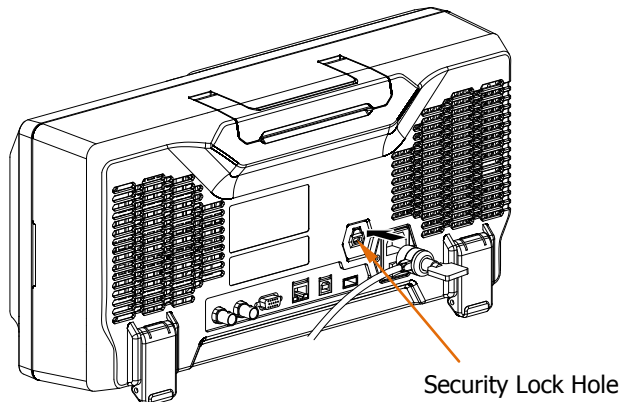

Figure 13 To Use the Security Lock

Note: do not insert other articles into the security lock hole to avoid damaging the instrument.



## To Use the Built-in Help System

The help system of this oscilloscope provides instructions for all the function keys (including menu keys) at the front panel. Press **Help** to open the help interface and press again to close the interface. The help interface mainly consists of two parts. The left is "Help Options" and you can use "Button" or "Index" mode for selection. The right is "Help Display Area".

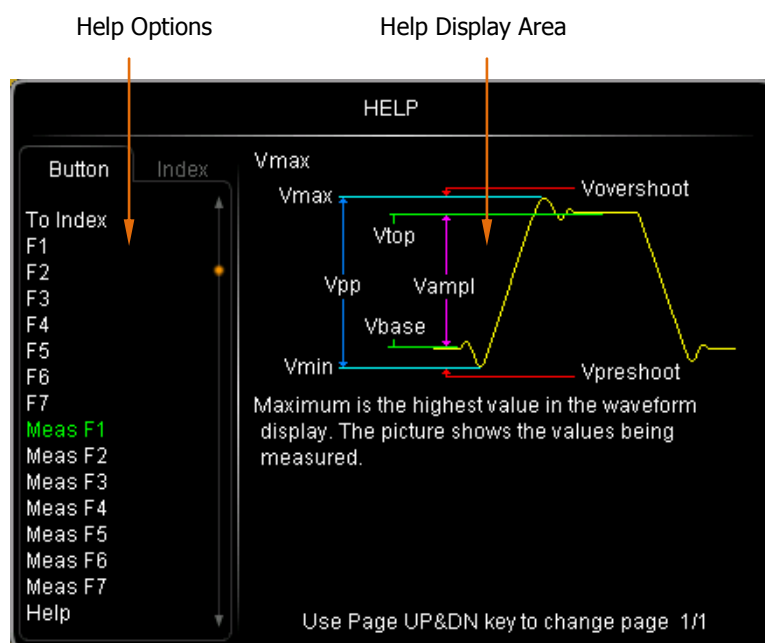







Figure 14 Help Information

### Button:

Default mode. In this mode, you can press the button (except the power key , the knob  and menu page up/down key ) at the front panel directly to get the corresponding help information of that button in the "Help Display Area".

Use  to select "To Index" and then press down the knob to switch to **Index** mode.

### Index:

In this mode, use  to select the item that needs to get help (for example: "Band Width"). The item currently selected is displayed with brown shading. Press down

the knob to get the corresponding help information in the “Help Display Area”.  
Use  to select “To Button” and then press down the knob to switch to **Button** mode.

# Troubleshooting

The commonly encountered failures and their solutions are listed below. When you encounter those problems, please solve them following the corresponding steps. If the problem remains still, please contact **RIGOL** and provide your device information (acquisition method: **Utility** → **System** → **System Info**).

## 1. The screen is still dark (no display) after power on:

- (1) Check if the power is correctly connected.
- (2) Check if the power switch is really on.
- (3) Check if the fuse is burned out. If the fuse needs to be changed, please return the instrument to the factory and **RIGOL** authorized personnel will change the fuse for you.
- (4) Restart the instrument after finishing the above inspections.
- (5) If it still does not work correctly, please contact **RIGOL**.

## 2. The signal is sampled but no waveform of the signal is displayed:

- (1) Check if the probe is correctly connected to the signal connecting wire.
- (2) Check if the signal connecting wire is correctly connected to the BNC (namely channel connector).
- (3) Check if the probe is correctly connected to the item under test.
- (4) Check if there are signals generated from the item under test (you can connect the probe compensation output signal to the problematic channel to determine which has problems, the channel or the item under test).
- (5) Resample the signal.

## 3. The tested voltage amplitude is ten times higher or lower than the actual value:

Check whether the attenuation coefficient of the channel complies with the attenuation ratio of the probe.

## 4. There is waveform display but not stable:

- (1) Check the trigger signal source: check whether the **Source** in the trigger menu complies with the signal channel actually used.
- (2) Check the trigger type: general signals should use "Edge" trigger and video signal should use "Video" trigger. Only when the proper trigger type is used,

can the waveform be displayed stably.

- (3) Try to change the **Coupling** to "HF Reject" or "LF Reject" to filter out the high-frequency or low-frequency noise that disturbs the trigger.
- (4) Change the trigger holdoff setting.

**5. No display after pressing **RUN/STOP**:**

Check if the **MODE** at the trigger panel (TRIGGER) is "Normal" or "Single" and if the trigger level exceeds the waveform range. If yes, set the trigger level to the middle or set the **MODE** to "Auto".

Note that using the **AUTO** button could automatically finish the above setting.

**6. The display of waveform is ladder-like:**

- (1) The horizontal time base might be too low. Increase the horizontal time base to increase the horizontal resolution and improve the display.
- (2) If **Type** is "Vectors", the lines between the sample points may cause ladder-like display. Set **Type** to "Dots" to solve the problem.

**7. The USB storage device can not be recognized:**

- (1) Check whether the USB storage device can work normally.
- (2) Make sure that the USB storage device used is flash storage type. This oscilloscope does not support hardware storage type.
- (3) Make sure if the capacity of the USB storage device is too large. It is recommended that the capacity of the USB storage device being used with this oscilloscope is no larger than 4 GBytes.
- (4) Restart the instrument and then insert the USB storage device.
- (5) If the USB storage device still can not be used normally, please contact **RIGOL**.