

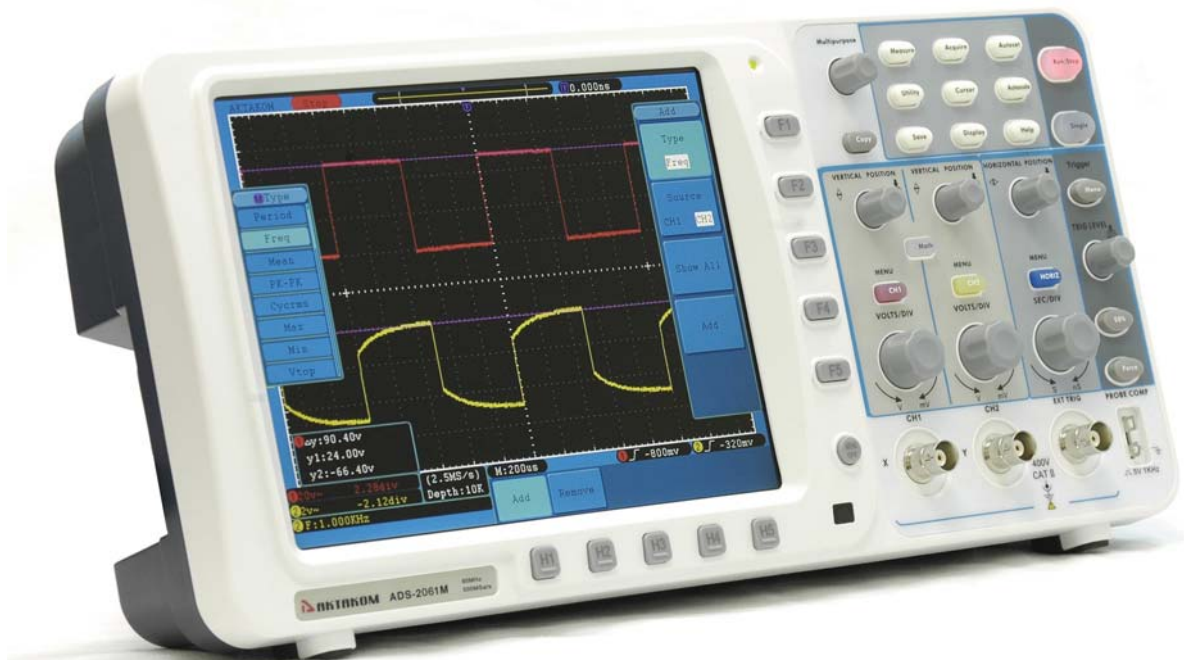

# ADS Series

## Smart Digital Storage Oscilloscopes

### User's Manual



■ ADS2061

■ ADS2061M

[www.tmatlantic.com](http://www.tmatlantic.com)



# General Warranty

The AKTAKOM warrants that the product will be free from defects in materials and workmanship for a period of three year from the date of purchase of the product by the original purchaser from the AKTAKOM Company. And the warranty period of accessories such as probe, battery, adapter is one year. This warranty only applies to the original purchaser and is not transferable to the third party. If the product proves defective during the warranty period, AKTAKOM either will repair the defective product without charge for parts and labor, or will provide a replacement in exchange for the defective product. Parts, modules and replacement products used by AKTAKOM for warranty work may be new or reconditioned to like new performance. All replaced parts, modules and products become the property of AKTAKOM.

In order to obtain service under this warranty, Customer must notify AKTAKOM of the defect before the expiration of the warranty period. Customer shall be responsible for packaging and shipping the defective product to the service center designated by AKTAKOM, and with a copy of customer proof of purchase.

This warranty shall not apply to any defect, failure or damage caused by improper use or improper or inadequate maintenance and care. AKTAKOM shall not be obligated to furnish service under this warranty a) to repair damage resulting from attempts by personnel other than AKTAKOM representatives to install, repair or service the product; b) to repair damage resulting from improper use or connection to incompatible equipment; c) to repair any damage or malfunction caused by the use of non-AKTAKOM supplies; or d) to service a product that has been modified or integrated with other products when the effect of such modification or integration increases the time or difficulty of servicing the product.

Please contact the nearest AKTAKOM's Sales and Service Offices for services or a complete copy of the warranty statement.

**Excepting the after-sales services provided in this summary or the applicable warranty statements, AKTAKOM will not offer any guarantee for maintenance definitely declared or hinted, including but not limited to the implied guarantee for marketability and special-purpose acceptability. AKTAKOM should not take any responsibilities for any indirect, special or consequent damages.**



# Table of Contents

<b>1. General Safety Requirements.....</b>	<b>1</b>
<b>2. Safety Terms and Symbols.....</b>	<b>2</b>
<b>3. General Characteristics.....</b>	<b>4</b>
<b>4. Junior User Guidebook .....</b>	<b>5</b>
<b>Introduction to the Structure of the Oscilloscope.....</b>	<b>6</b>
Front panel .....	6
Left side panel .....	7
Right side panel .....	7
Rear Panel .....	8
Control (key and knob) area .....	9
<b>User interface introduction.....</b>	<b>10</b>
<b>How to implement the General Inspection.....</b>	<b>12</b>
<b>How to implement the Function Inspection .....</b>	<b>13</b>
<b>How to Implement the Probe Compensation .....</b>	<b>14</b>
<b>How to Set the Probe Attenuation Coefficient.....</b>	<b>14</b>
<b>How to Use the Probe Safely.....</b>	<b>15</b>
<b>How to Implement Auto-calibration.....</b>	<b>16</b>
<b>Introduction to the Vertical System.....</b>	<b>16</b>
<b>Introduction to the Horizontal System .....</b>	<b>17</b>
<b>Introduction to the Trigger System .....</b>	<b>18</b>
<b>5. Advanced User Guidebook .....</b>	<b>20</b>
<b>How to Set the Vertical System .....</b>	<b>21</b>
Implementation of Mathematical Manipulation Function .....	25
Using FFT function .....	27
<b>Application of VERTICAL POSITION and VOLTS/DIV Knobs.....</b>	<b>31</b>
<b>How to Set the Horizontal System .....</b>	<b>31</b>
<b>How to set the Trigger System .....</b>	<b>34</b>
Single trigger .....	34
Alternate trigger .....	38
<b>How to Operate the Function Menu .....</b>	<b>42</b>
How to Implement Sampling Setup .....	42
How to Set the Display System .....	44
How to Save and Recall a Waveform.....	49
How to Record/Playback Waveforms .....	51
How to Implement the Auxiliary System Function Setting.....	54
How to Measure Automatically.....	58

How to measure with cursors .....	62
How to use Autoscale.....	67
How to Use Executive Buttons.....	69
<b>6. Demonstration .....</b>	<b>71</b>
<b>Example 1: Measurement of Simple Signals.....</b>	<b>71</b>
<b>Example 2: Gain of the Amplifier in the Metering Circuit .....</b>	<b>72</b>
<b>Example 3: Capture the Single Signal .....</b>	<b>73</b>
<b>Example 4: Analyze the Details of a Signal.....</b>	<b>75</b>
<b>Example 5: Application of X-Y Function .....</b>	<b>77</b>
<b>Example 6: Video Signal Trigger .....</b>	<b>78</b>
<b>7. F.A.Q .....</b>	<b>80</b>
<b>8. Technical Specifications.....</b>	<b>82</b>
<b>General Technical Specifications .....</b>	<b>86</b>
<b>9. Appendix .....</b>	<b>87</b>
<b>Appendix A: Enclosure .....</b>	<b>87</b>
<b>Appendix B: Maintenance, Cleaning and Repairing .....</b>	<b>87</b>
<b>Appendix C: Battery Using Guide .....</b>	<b>88</b>

---

# 1. General Safety Requirements

**Before any operations, please read the following safety precautions to avoid any possible bodily injury and prevent this product or any other products connected from damage. In order to avoid any contingent danger, this product is only used within the range specified.**

Only the qualified technicians can implement the maintenance.

**Prevent the Fire or Bodily Injury.**

**Connect the probe correctly. The grounding end of the probe corresponds to the grounding phase. Please don't connect the grounding end to the positive phase.**

**Use the proper power line.** Only use the power cord specially provided for this product or that has been approved to be used in this user state.

**Connect or Disconnect Correctly.** When the probe or testing wire is connected to the power lead, please do not connect and disconnect the probe or testing wire at random.

**Product Grounded.** This product is grounded through the power lead grounding conductor. In order to prevent any electric shocking, the grounding conductor must be connected to the ground. It requires guarantee that this product has been already grounded correctly before any connection with its input or output terminal.

When powered by AC power, it is not allowed to measure AC power source directly, because the testing ground and power cord ground conductor are connected together, otherwise, it will cause short circuit.

When powered by battery, the product must ground connection. To avoid electric shock, there must be a ground wire connect between ground and the ground port (on the back of product panel).

**Pay attention to the nominal values of all terminals.** In order to prevent any fire or electric shock risks, please pay attention to all the nominal values and marks of this product. Before implement any connections for this product, please read the user's manual of this product to understand the information about the rated values further.

**Do not make any operations without the instrument cover installed.** If the cover or panel has already been removed, please don't operate this product.

**Use the proper fuse.** Only the fuse complying with the specified type and nominal value for this product can be used.

**Avoid touching any exposed circuit.** When the product is on power, please don't touch the uncovered contacts and parts.

**Please don't make any operations while there is an uncertain fault emerged.** If suspecting damage to this product, please contact the qualified maintenance personnel for check.

**Keep a good ventilation condition.** Please consult the detailed installation instruction in the user's manual so that this product can be erected correctly, keeping it under a good ventilation condition.

**Please do not make any operations in a moist environment.**

**Please do not make any operates in an explosive environment.**

**Keep the products surface clean and dry.**

---

## 2. Safety Terms and Symbols

### Safety Terms

**Terms in this manual:** The following terms may appear in this manual:



**Warning:** A warning statement indicates the conditions and actions which may endanger the life safety.



**Note:** A note statement indicates the conditions and actions which may cause damage to this product or other property.

**Terms on the product:** The following terms may appear on this product:

**Danger:** It indicates that there may be an immediate injury to you when you encounter this mark.

**Warning:** It indicates that there may not be an immediate injury to you when you encounter this mark.

**Note:** It indicates that there may be damage to this product or other property.

### Safety Symbols

**Symbols on the product:** The following symbol may appear on the products:



High Voltage



Please Consult the Manual



Protective Ground End



Earth End on the Shell



Grounding End for Measurement



---

To avoid body damage and prevent product and connected equipment dam. This product can only be used in the specified applications. Carefully read the following safety information before using the test tool.

---

 **Warning:**

**To avoid fire or electrical shock if an oscilloscope input is connected to more than 42V peak (30Vrms) or on circuits of more than 4800VA, please take note of below items:**

- **Only use accessory insulated voltage probes or test lead.**
  - **Before using oscilloscope, please inspect oscilloscope accessories such as probe to see if they are in good condition, if not, please replace them.**
  - **Remove probes, test leads and other accessories that are not necessary use.**
  - **Remove USB cable which connects oscilloscope and computer.**
  - **Please pay special attention when the probe is set as 1:1 and do not apply input voltages above the rating of the instrument because the probe tip voltage will directly transmit to the oscilloscope.**
  - **Do not use exposed metal BNC or banana plug connectors.**
  - **Do not insert metal objects into connectors.**
-

---

## 3. General Characteristics

- Bandwidth: 60MHz — 300 MHz;
- Sample rate(real time): 500MS/s — 3.2GS/s;
- Dual channel, 10M points on each channel for the Record length;
- Autoscale function;
- 7cm smart design body;
- 8 inch high definition TFT display (800 x 600 pixels);
- Built-in FFT function;
- Pass/Fail Function, optically isolated Pass/Fail output;
- Waveform record and playback;
- VGA output;
- Various triggering function;
- USB communication ports;
- Super capacity lithium battery (Optional);
- Built-in Chinese and English help system;
- Multiple language user interfaces.

---

## 4. Junior User Guidebook

**This chapter deals with the following topics mainly:**

- Introduction to the structure of the oscilloscope
- Introduction to the user interface
- How to implement the general inspection
- How to implement the function inspection
- How to make a probe compensation
- How to set the probe attenuation coefficient
- How to use the probe safely
- How to implement an auto-calibration
- Introduction to the vertical system
- Introduction to the horizontal system
- Introduction to the trigger system

## Introduction to the Structure of the Oscilloscope

When you get a new-type oscilloscope, you should get acquainted with its front panel at first and the SDS series digital storage oscilloscope is no exception. This chapter makes a simple description of the operation and function of the front panel of the SDS series oscilloscope, enabling you to be familiar with the use of the SDS series oscilloscope in the shortest time.

### Front panel

The SDS series oscilloscope offers a simple front panel with distinct functions to users for their completing some basic operations, in which the knobs and function pushbuttons are included. The knobs have the functions similar to other oscilloscopes. The 5 buttons (F1 ~ F5) in the column on the right side of the display screen or in the row under the display screen (H1 ~ H5) are menu selection buttons, through which, you can set the different options for the current menu. The other pushbuttons are function buttons, through which, you can enter different function menus or obtain a specific function application directly.

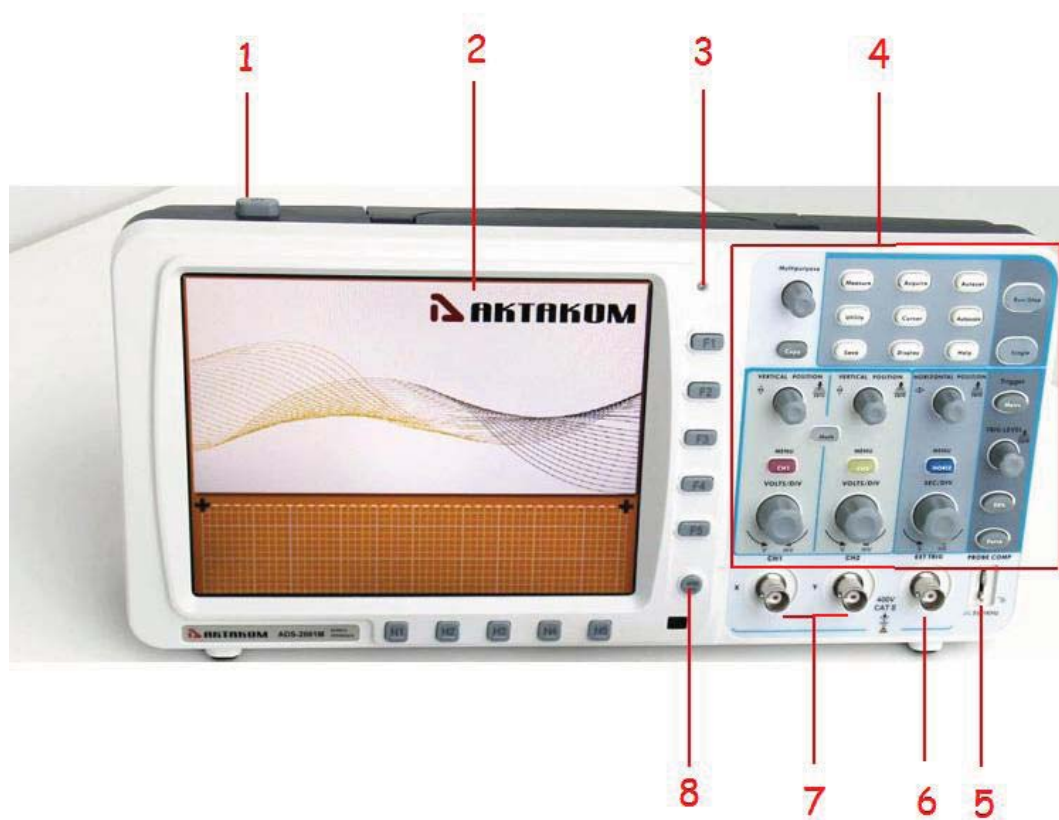

Fig. 4-1 Front panel

1. Power on/off
2. Display area
3. Power indication light

**Green light:** Indicating DSO connects with AC Power, and the battery is in full (if User Manual of Smart Digital Storage Oscilloscope

---

there is battery inside DSO).

**Yellow light:** Indicating DSO connect with AC Power and the battery is in charging (if there is battery inside DSO)

**Dim:** Only powered by battery without connecting AC Power

4. Control (key and knob) area
5. Probe Compensation: Measurement signal(5V/1KHz) output
6. EXT Trigger Input
7. Signal Input Channel
8. Menu off

## Left side panel



Fig. 4-2 Left side panel

1. Power switch: “—” represents power ON; “○” represents power OFF.
2. AC power input jack

## Right side panel

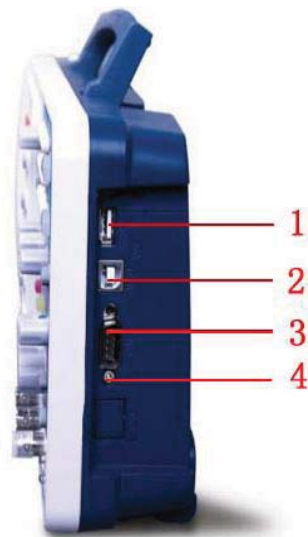

Fig. 4-3 Right side panel

1. **USB Host port:** It is used to transfer data when external USB equipment connects to

the oscilloscope regarded as “Host equipment”. For example: upgrading software by USB flash disk needs to use this port.

2. **USB Device port:** It is used to transfer data when external USB equipment connects to the oscilloscope regarded as “Device equipment”. For example: to use this port when connect PC to the oscilloscope by USB.
3. **COM / VGA port:** To connect the oscilloscope with external equipment as serial port, or to connect the oscilloscope with a monitor or a projector as VGA output.
4. **LAN** (function reserved)

## Rear Panel



Fig. 4-4 Rear Panel

1. The port of trigger signal output & Pass/Fail output
2. Handle
3. Air vents
4. Foot stool (can adjust the tilt angle of the oscilloscope)
5. Ground connection

## Control (key and knob) area

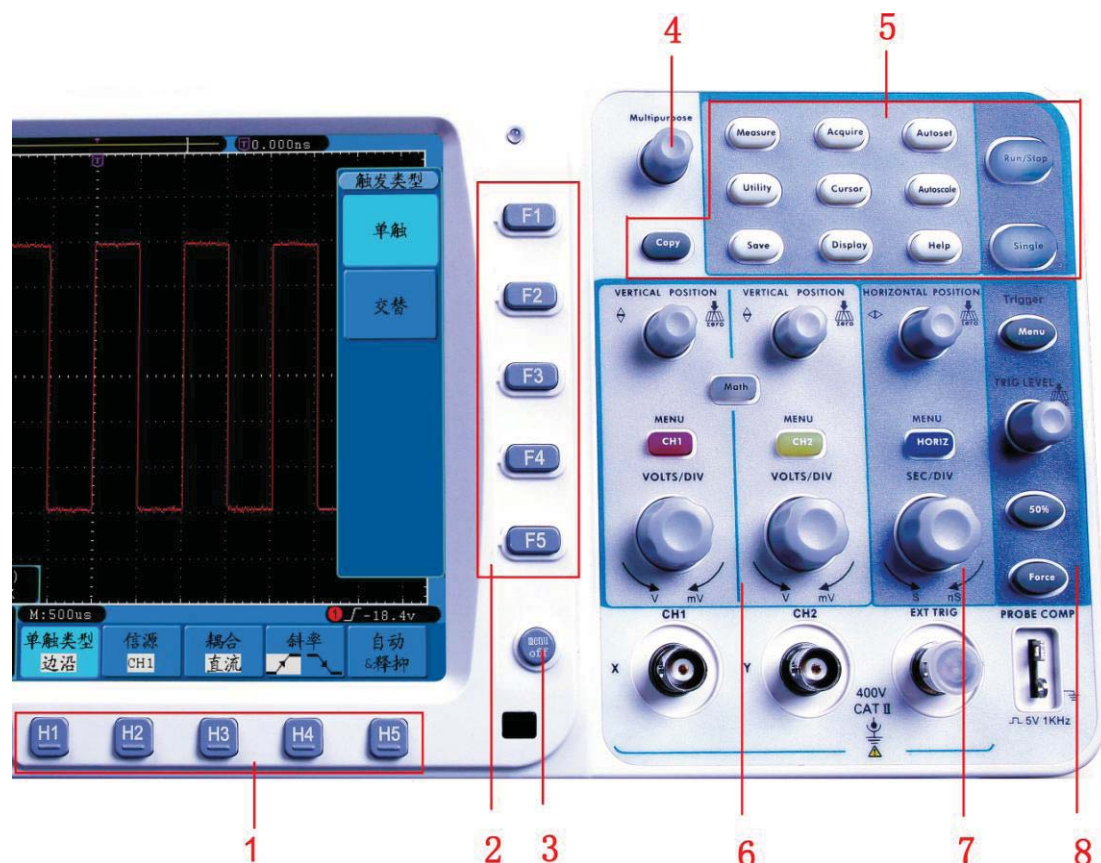

Fig. 4-5 Keys Overview

1. Menu option setting: H1~H5
2. Menu option setting: F1~F5
3. Menu off: turn off the menu
4. M knob(Multipurpose knob)
5. Function key area: Total 12 keys
6. Vertical control area with 3 keys and 4 knobs.  
 “CH1 MENU” and “CH2 MENU” correspond to setting menu in CH1 and CH2, “Math” key refer to math menu, the math menu consists of six kinds of operations, including CH1-CH2, CH2-CH1, CH1+CH2, CH1\*CH2, CH1/CH2 and FFT. Two “VERTICAL POSITION” knob control the vertical position of CH1/CH2, and two “VOLTS/DIV” knob control voltage scale of CH1, CH2.
7. Horizontal control area with 1 key and 2 knobs.  
 “HORIZONTAL POSITION” knob control trigger position, “SEC/DIV” control time base, “HORIZ MENU” key refer to horizontal system setting menu.
8. Trigger control area with 3 keys and 1 knob.  
 “TRIG LEVEL” knob is to adjust trigger voltage. Other 3 keys refer to trigger system setting.

## User interface introduction

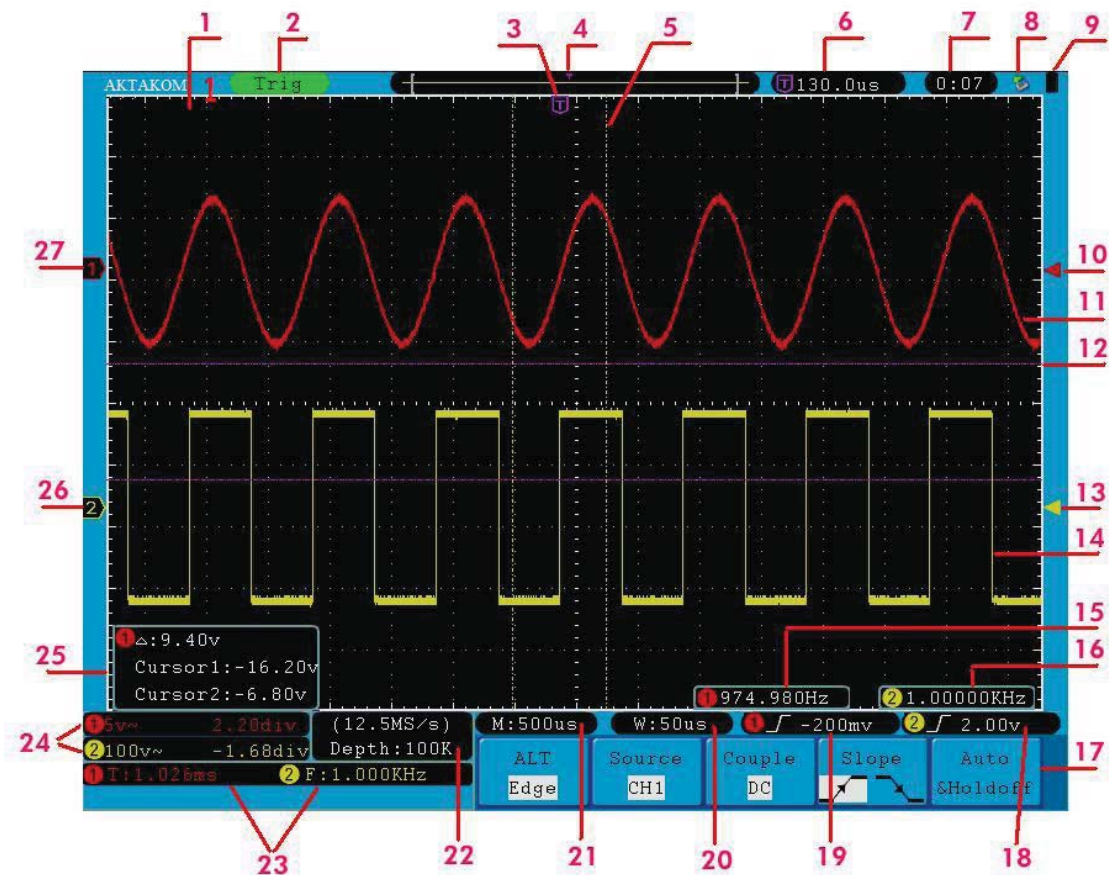

Fig. 4-6 Illustrative Drawing of Display Interfaces

1. Waveform Viewing Area.
2. The Trigger State indicates the following information:

Auto: The oscilloscope is under the Automatic mode and is collecting the waveform under the non-trigger state.

Trig: The oscilloscope has already detected a trigger signal and is collecting the after-triggering information.

Ready: All pre-triggered data have been captured and the oscilloscope has been already ready for accepting a trigger.





Scan: The oscilloscope captures and displays the waveform data continuously in the scan mode.

Stop: The oscilloscope has already stopped the waveform data acquisition.



3. The purple pointer indicates the horizontal trigger position, which can be adjusted by the horizontal position control knob.
4. The pointer indicates the trigger position in the internal memory.
5. The two yellow dotted lines indicate the size of the viewing expanded window.



- 
6. It shows present triggering value and displays the site of present window in internal memory.
  7. It shows setting time (see “Config” on P54 ).
  8. It indicates that there is a U disk connecting with the oscilloscope.
  9. Indicating battery power status (see “Display” on P55 ).
  10. The red pointer shows the trigger level position for CH1.
  11. The waveform of CH1.
  12. The positions of two purple dotted line cursors measurements.
  13. The yellow pointer shows the trigger level position for CH2.
  14. The waveform of CH2.
  15. The frequency of the trigger signal of CH1.
  16. The frequency of the trigger signal of CH2.
  17. It indicates the current function menu.
  - 18/19. It shows the selected trigger type:

- |   |                                    |
|---|------------------------------------|
|    | Rising edge triggering             |
|  | Falling edge triggering            |
|  | Video line synchronous triggering  |
|  | Video field synchronous triggering |

The reading shows the trigger level value of the corresponding channel.

20. The reading shows the window time base value.
21. The reading shows the setting of main time base.
22. The readings show current sample rate and the record length.
23. It indicates the measured type and value of the corresponding channel. “F” means frequency, “T” means cycle, “V” means the average value, “Vp” the peak-peak value, “Vk” the root-mean-square value, “Ma” the maximum amplitude value, “Mi” the minimum amplitude value, “Vt” the Voltage value of the waveform’s flat top value, “Vb” the Voltage value of the waveform’s flat base, “Va” the amplitude value, “Os” the overshoot value, “Ps” the Pres hoot value, “RT” the rise time value, “FT” the fall time value, “PW” the +width value, “NW” the -Width value, “+D” the +Duty value, “-D” the -Duty value, “PD” the Delay A->B  value and “ND” the Delay A->B  value.
24. The readings indicate the corresponding Voltage Division and the Zero Point positions of the channels.

The icon shows the coupling mode of the channel.

“—” indicates the direct current coupling

---

“ ~ ” indicates the AC coupling

“  $\perp$  ” indicates GND coupling

25. It is cursor measure window, showing the absolute values and the readings of the two cursors.
26. The yellow pointer shows the grounding datum point (zero point position) of the waveform of the CH2 channel. If the pointer is not displayed, it shows that this channel is not opened.
27. The red pointer indicates the grounding datum point (zero point position) of the waveform of the CH1 channel. If the pointer is not displayed, it shows that the channel is not opened.

**Note:**

If a  symbol appears in the menu, it indicates you can turn the **M** knob to set the current menu.

## How to implement the General Inspection

After you get a new SDS series oscilloscope, it is recommended that you should make a check on the instrument according to the following steps:

**1. Check whether there is any damage caused by transportation.**

If it is found that the packaging carton or the foamed plastic protection cushion has suffered serious damage, do not throw it away first till the complete device and its accessories succeed in the electrical and mechanical property tests.

**2. Check the Accessories**



The supplied accessories have been already described in the **Appendix B** “Accessories” of this Manual. You can check whether there is any loss of accessories with reference to this description. If it is found that there is any accessory lost or damaged, please get in touch with the distributor of AKTAKOM responsible for this service or the AKTAKOM’s local offices.

**3. Check the Complete Instrument**

If it is found that there is damage to the appearance of the instrument, or the instrument cannot work normally, or fails in the performance test, please get in touch with the AKTAKOM’s distributor responsible for this business or the AKTAKOM’s local offices. If there is damage to the instrument caused by the transportation, please keep the package. With the transportation department or the AKTAKOM’s distributor responsible for this business informed about it, a repairing or replacement of the instrument will be arranged by the AKTAKOM.

## How to implement the Function Inspection

Make a fast function check to verify the normal operation of the instrument, according to the following steps:

1. **Connect the power cord to a power source. Turn on the Power Switch Button  on the left side (make sure the “—” side is pressed down). Then, push down the button of the “” signal on the top.**

The instrument carries out all self-check items and shows the Boot Logo. Press the “Utility” button, then, press **H1** button to get access to the “Function” menu. Turn the **M** knob to select **Adjust** and press **H3** button to select “Default”. The default attenuation coefficient set value of the probe in the menu is 10X.

2. **Set the Switch in the Oscilloscope Probe as 10X and Connect the Oscilloscope with CH1 Channel.**

Align the slot in the probe with the plug in the CH1 connector BNC, and then tighten the probe with rotating it to the right side.

Connect the probe tip and the ground clamp to the connector of the probe compensator.

3. **Press the “Autoset” Button.**

The square wave of 1 KHz frequency and 5V peak-peak value will be displayed in several seconds (see Fig. 4-7).

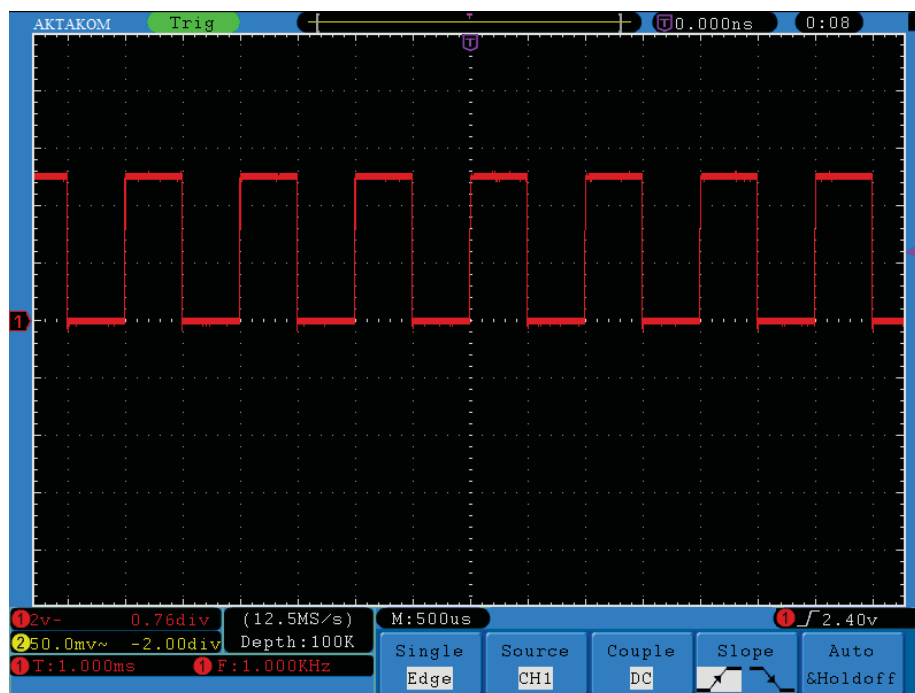

Fig.4-7 Auto set

Check CH2 by repeating Step 2 and Step 3.

---

## How to Implement the Probe Compensation

When connect the probe with any input channel for the first time, make this adjustment to match the probe with the input channel. The probe which is not compensated or presents a compensation deviation will result in the measuring error or mistake. For adjusting the probe compensation, please carry out the following steps:

1. Set the attenuation coefficient of the probe in the menu as 10X and that of the switch in the probe as 10X (see “How to Set the Probe Attenuation Coefficient” on P14), and connect the oscilloscope probe with the CH1 channel. If a probe hook tip is used, ensure that it keeps in close touch with the probe. Connect the probe tip with the signal connector of the probe compensator and connect the reference wire clamp with the ground wire connector of the probe connector, and then press the button “Autoset”.
2. Check the displayed waveforms and regulate the probe till a correct compensation is achieved (see Fig.4-8 and Fig.4-9).

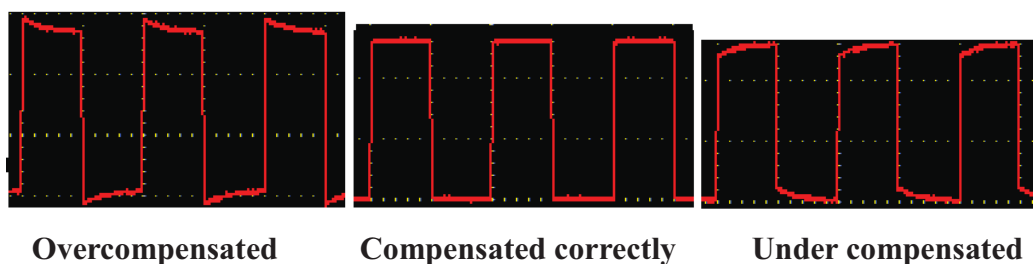

**Fig. 4-8** Displayed Waveforms of the Probe Compensation

3. Repeat the steps mentioned if necessary.

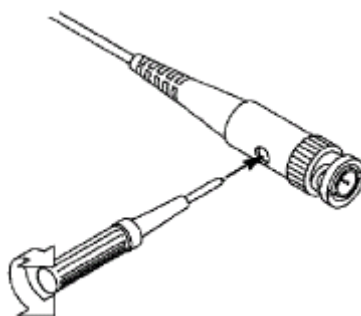

**Fig. 4-9** Adjust Probe

## How to Set the Probe Attenuation Coefficient

The probe has several attenuation coefficients, which will influence the vertical scale factor of the oscilloscope.

To change or check the probe attenuation coefficient in the menu of oscilloscope:

- (1) Press the function menu button of the used channels (**CH1 MENU** or **CH2**

---

**MENU).**

- (2) Press **H3** button to display the Probe menu; select the proper value corresponding to the probe.

This setting will be valid all the time before it is changed again.



**Note:** The attenuation coefficient of the probe in the menu is preset to 10X when the oscilloscope is delivered from the factory.

Make sure that the set value of the attenuation switch in the probe is the same as the menu selection of the probe attenuation coefficient in the oscilloscope.

---

The set values of the probe switch are 1X and 10X (see Fig. 4-10).

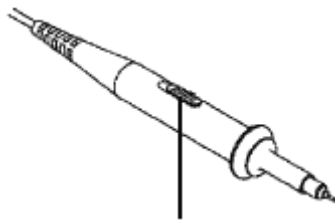

**Fig.4-10** Attenuation Switch



**Note:** When the attenuation switch is set to 1X, the probe will limit the bandwidth of the oscilloscope in 5MHz. If it is needed to use the full bandwidth of the oscilloscope, the switch must be set to 10X.

---

## How to Use the Probe Safely

The safety guard ring around the probe body protects your finger against the electric shock, shown as Fig. 4-11.

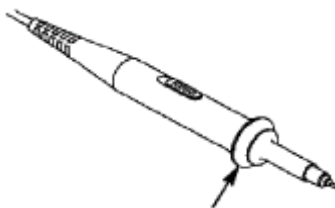

**Fig. 4-11** Finger Guard



### Warning:

In order to avoid suffering from the electric shock, please keep your finger behind the safety guard ring of the probe body during the operation.

In order to protect you from suffering from the electric shock during your using the probe, do not touch the metal part of the probe tip when the probe is connected to the power supply.

Before making any measurements, please connect the probe to the instrument and connect the ground terminal to the earth.

## How to Implement Auto-calibration

The auto-calibration application can make the oscilloscope reach the optimum condition rapidly to obtain the most accurate measurement value. You can carry out this application program at any time, but when the range of variation of the ambient temperature is up to or over 5°C, this program must be executed.

For the performing of the self-calibration, all probes or wires should be disconnected with the input connector first. Press the “Utility” button, then, press **H1** button to call out the **Function** menu; turn the **M** knob to choose **Adjust**. Press **H2** button to choose the option “Self Cal”; run the program after everything is ready.

## Introduction to the Vertical System

Shown as Fig.4-9, there are a series of buttons and knobs in **VERTICAL CONTROLS**. The following practices will gradually direct you to be familiar with the using of the vertical setting.



Fig. 4-12 Vertical Control Zone

1. Use the button “**VERTICAL POSITION**” knob to show the signal in the center of the waveform window. The “**VERTICAL POSITION**” knob functions the regulating of the vertical display position of the signal. Thus, when the

---

“**VERTICAL POSITION**” knob is rotated, the pointer of the earth datum point of the channel is directed to move up and down following the waveform.

### **Measuring Skill**

If the channel is under the DC coupling mode, you can rapidly measure the DC component of the signal through the observation of the difference between the waveform and the signal ground.

If the channel is under the AC mode, the DC component will be removed by filtration. This mode helps you display the AC component of the signal with a higher sensitivity.

### **Vertical offset back to 0 shortcut key**

Turn the **VERTICAL POSITION** knob to change the vertical display position of channel and press the position knob to set the vertical display **position** back to 0 as a shortcut key, this is especially helpful when the trace position is far out of the screen and want it to get back to the screen center immediately.

2. Change the Vertical Setting and Observe the Consequent State Information Change.

With the information displayed in the status bar at the bottom of the waveform window, you can determine any changes in the channel vertical scale factor.

- Turn the vertical “**VOLTS/DIV**” knob and change the “Vertical Scale Factor (Voltage Division)”, it can be found that the scale factor of the channel corresponding to the status bar has been changed accordingly.
- Press buttons of “**CH1 MENU**”, “**CH2 MENU**” and “**Math**”, the operation menu, symbols, waveforms and scale factor status information of the corresponding channel will be displayed in the screen.

## **Introduction to the Horizontal System**

Shown as Fig.4-10, there are a button and two knobs in the “**HORIZONTAL CONTROLS**”. The following practices will gradually direct you to be familiar with the setting of horizontal time base.



**Fig. 4-13** Horizontal Control Zone

1. Use the horizontal “**SEC/DIV**” knob to change the horizontal time base setting and observe the consequent status information change. Rotate the horizontal “**SEC/DIV**” knob to change the horizontal time base, and it can be found that the “**Horizontal Time Base**” display in the status bar changes accordingly. The horizontal scanning speed steps from 5ns up to 100s in the sequence of 1-2-5 ADS2061 or ADS2061
2. Use the “**HORIZONTAL POSITION**” knob to adjust the horizontal position of the signal in the waveform window. The “**HORIZONTAL POSITION**” knob is used to control the triggering displacement of the signal or for other special applications. If it is applied to triggering the displacement, it can be observed that the waveform moves horizontally with the knob when you rotate the “**HORIZONTAL POSITION**” knob.
3. With the “**HORIZ MENU**” button, you can do the Window Setting and the Window Expansion.

## Introduction to the Trigger System

Shown as Fig.4-11, there are a knob and three buttons in the “**TRIGGER CONTROLS**”. The following practices will direct you to be familiar with the setting of the trigger system gradually.





**Fig.4-14** Trigger Control Zone

1. Press the “**Trigger Menu**” button and call out the trigger menu. With the operations of the menu selection buttons, the trigger setting can be changed.
2. Use the “**TRIG LEVEL**” knob to change the trigger level setting.  
With the rotation of the “**TRIG LEVEL**” knob, it can be found that the trigger indicator in the screen will move up and down with the rotation of the knob. With the movement of the trigger indicator, it can be observed that the trigger level value displayed in the screen changes.  
**PS:** Turning the **TRIG LEVEL** knob can change trigger level value and it is also the hotkey to set trigger level back to 0.
3. Press the button “**50%**” to set the trigger level as the vertical mid point values of the amplitude of the trigger signal.
4. Press the “**Force**” button to force a trigger signal, which is mainly applied to the “Normal” and “Single” trigger modes.

---

## 5. Advanced User Guidebook

Up till now, you have already been familiar with the initial operations of the functions of the function areas, buttons and knobs in the front panel of the SDS series oscilloscope. Based the introduction of the previous Chapter, the user should have an intimate knowledge of the determination of the change of the oscilloscope setting through observing the status bar. If you have not been familiar with the above-mentioned operations and methods yet, we advise you to read the section of “Chapter One Junior Users' Guidebook”.

This chapter will deal with the following topics mainly:

- **How to Set the Vertical System**
- **How to Set the Horizontal System**
- **How to Set the Trigger System**
- **How to Implement the Sampling Setup**
- **How to Set the Display System**
- **How to Save and Recall Waveform**
- **How to Record/Playback Waveforms**
- **How to Implement the Auxiliary System Function Setting**
- **How to Implement the Automatic Measurement**
- **How to Implement the Cursor Measurement**
- **How to Use Auto scale function**
- **How to Use Executive Buttons**

It is recommended that you read this chapter carefully to get acquainted the various measurement functions and other operation methods of the SDS series oscilloscope.

## How to Set the Vertical System

The **VERTICAL CONTROLS** includes three menu buttons such as **CH1 MENU**, **CH2 MENU** and **Math**, and four knobs such as **VERTICAL POSITION**, **VOLTS/DIV** (one group for each of the two channels).

### Setting of CH1 and CH2

Every channel has an independent vertical menu and each item is set respectively based on the channel.

### To turn waveforms on or off (channel, math)

Pressing the **CH1 MENU**, **CH2 MENU**, and **Math** buttons have the following effect:

- If the waveform is off, the waveform is turned on and its menu is displayed.
- If the waveform is on and its menu is not displayed, its menu will be displayed.
- If the waveform is on and its menu is displayed, the waveform is turned off and its menu goes away.

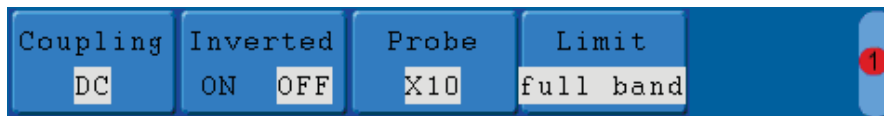

CH1 menu

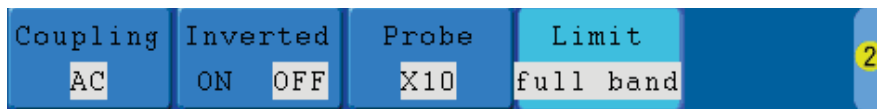

CH2 menu

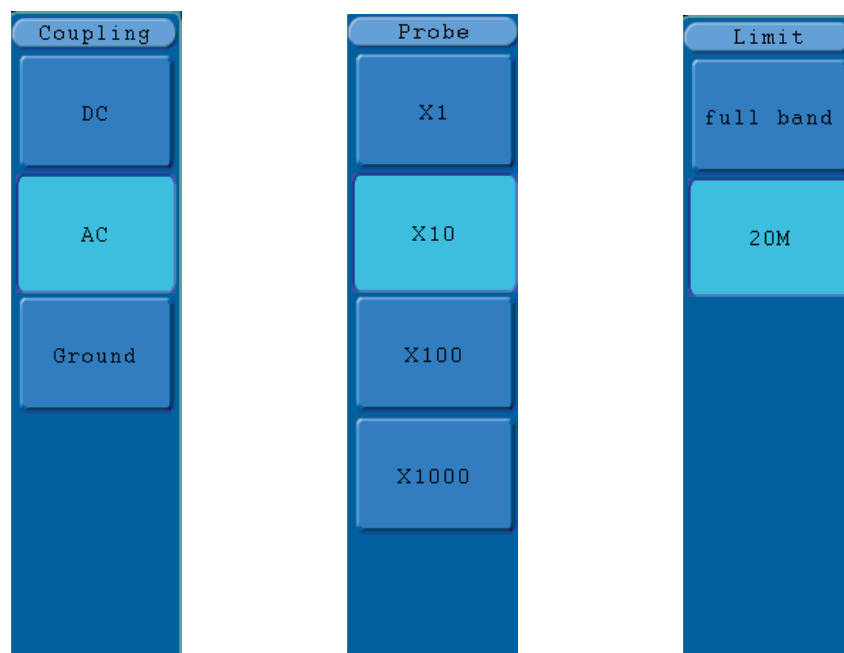

Couple setting

Probe setting

Limit setting

**Fig. 5-1** Channel Setting Menu

The description of the Channel Menu is shown as the following list:

Function Menu	Setting	Description
Coupling	DC	Unblock the AC and DC components in the input signal.
	AC	Block the DC component in the input signal.
	GROUND	The Input signal is interrupted.
Inverted	OFF	The waveform is displayed normally.
	ON	Initiate the waveform inverted function.
Probe	1X	Choose one according to the probe attenuation factor to make the vertical scale reading accurate.
	10X	
	100X	
	1000X	
Limit	full band	Get full bandwidth.
	20M	Limit the channel bandwidth to 20MHz to reduce display noise.

### 1. Setting Channel Coupling

Taking the Channel 1 for example, the measured signal is a square wave signal containing the direct current bias. The operation steps are shown as below:

- (1) Press the **CH1 MENU** button and call out the CH1 SETUP menu.
- (2) Press the **H1** button, the Coupling menu will display at the screen.
- (3) Press the **F1** button again to select the Coupling item as “**DC**”. By setting the channel coupling as DC mode, both DC and AC components of the signal will be passed.
- (4) Then, press **F2** button to select the Coupling item as “**AC**”. By setting the channel coupling as AC mode, the direct current component of the signal will be blocked. The waveforms are shown as Fig.5-2.

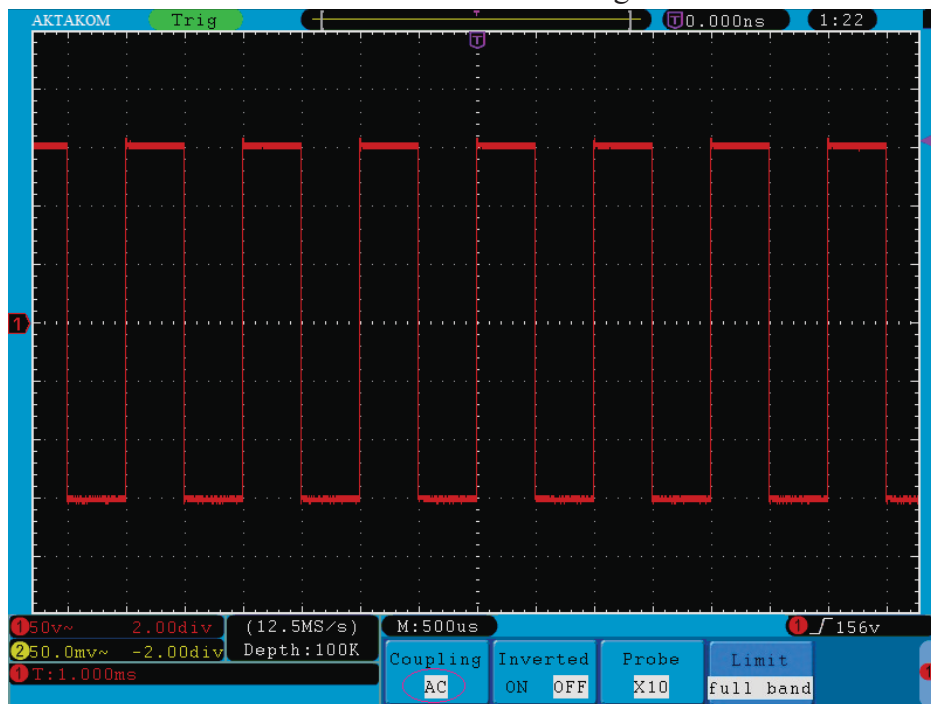

Fig. 5-2 AC Coupling Oscillogram

## 2. Regulate the probe attenuation.

In order to match the attenuation coefficient of the probe, it is required to adjust the attenuation ratio coefficient of the probe through the operating menu of the Channel accordingly (see “How to Set the Probe Attenuation Coefficient” on P14). If the attenuation coefficient of the probe is 1:1, that of the oscilloscope input channel should also be set to 1X to avoid any errors presented in the displayed scale factor information and the measured data.

Take the Channel 1 as an example, the attenuation coefficient of the probe is 10:1, the operation steps is shown as follows:

- (1) Press the **CH1 MENU** button, access CH1 SETUP menu.
- (2) Press the **H3** menu selection, the Probe menu will display at the right of the screen, then press the **F2** button to select **10X** for the probe.

The Fig.5-3 illustrates the setting and the vertical scale factor when the probe of the attenuation coefficient of 10:1 is used.

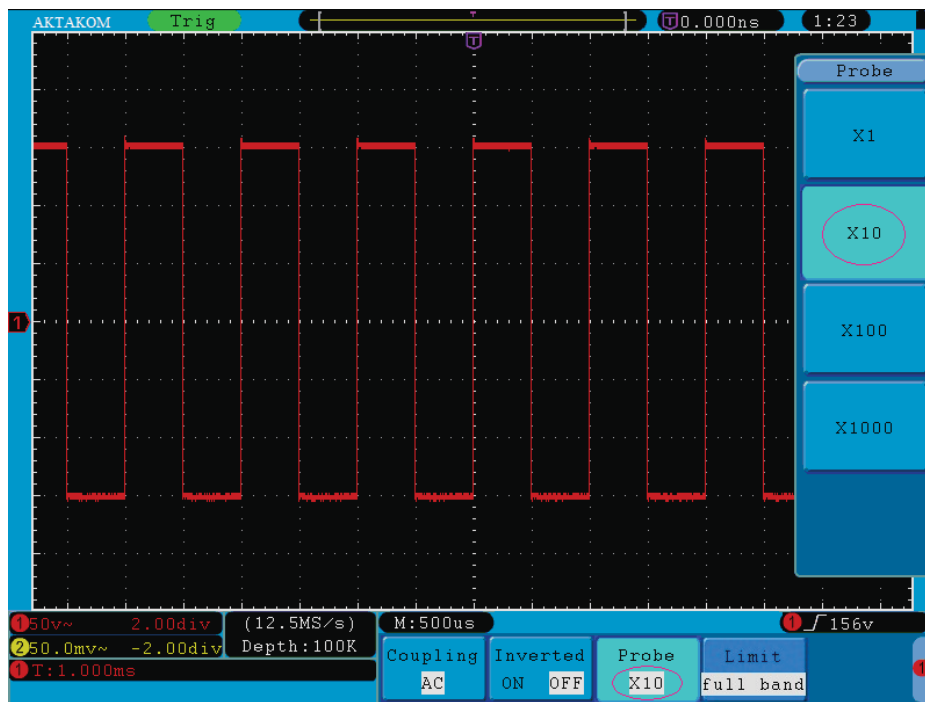

**Fig. 5-3 Regulation of the Attenuation Ratio of the Probe**

A List of the Attenuation Coefficient of Probes and the Corresponding Menu Settings:

Attenuation Coefficient of the Probe	Corresponding Menu Setting
1:1	X1
10:1	X10
100:1	X100
1000:1	X1000

## 3. Setting of Waveform Inverted

Waveform inverted: the displayed signal is turned 180 degrees against the phase of the earth potential.

Taking the Channel 1 for example, the operation steps are shown as follows:

- (1) Press the **CH1 MENU** button and get access to the **CH1 SETUP** menu.
- (2) Press the **H2** menu selection button and select **ON** for **Inverted** item. The waveform inverted function is initiated.
- (3) Press the **H2** menu selection button again and select **OFF** for **Inverted** item. The function of waveform inverted is closed off.

For the screen display, see Fig. 5-4 and Fig. 5-5

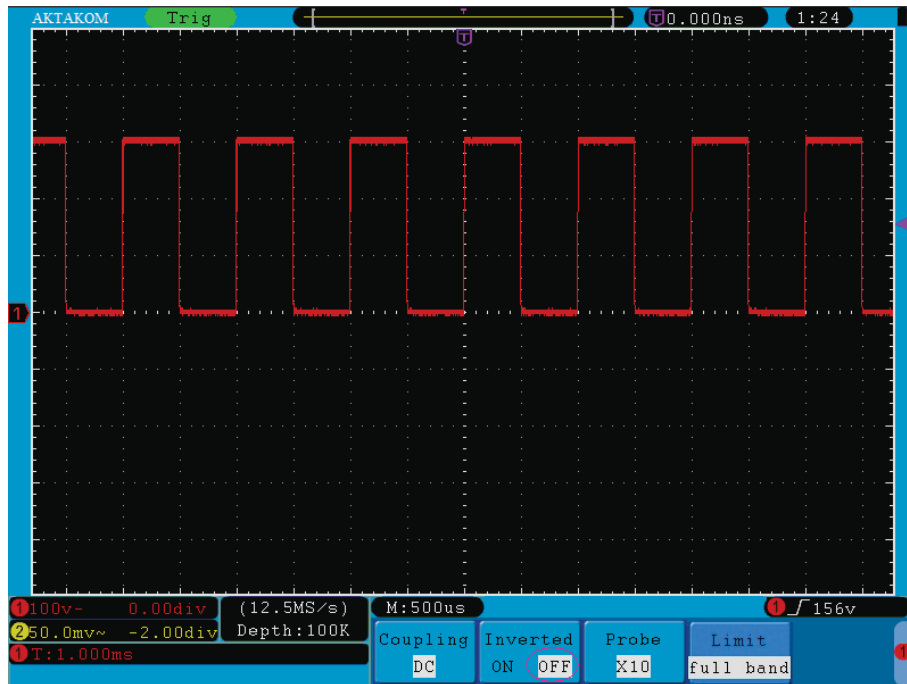

Fig. 5-4 Waveform not inverted

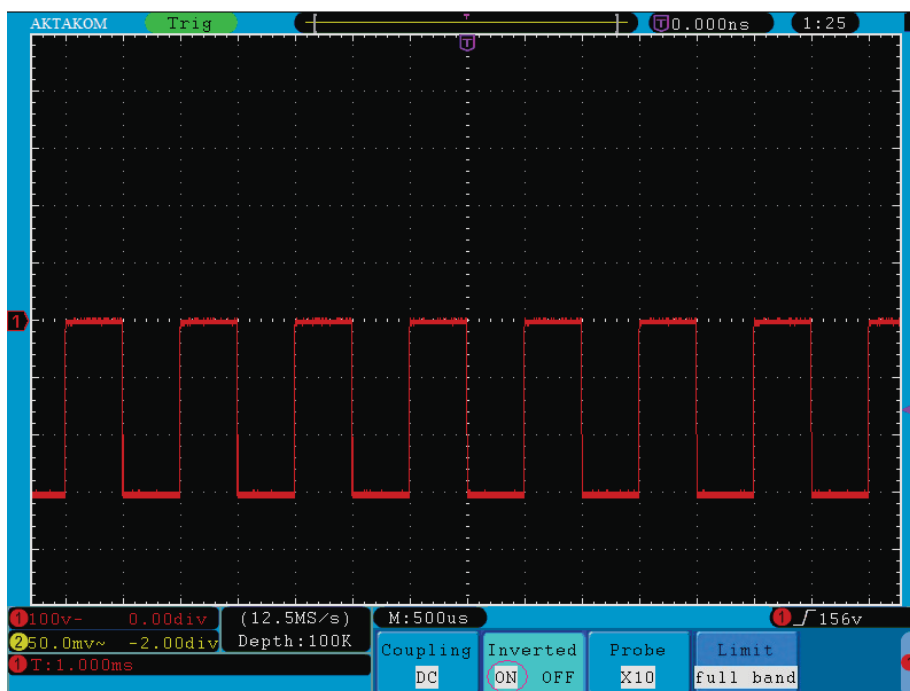

Fig. 5-5 Waveform Inverted

#### 4. Setting of Band Limit

When high frequency components of a waveform are not important to its analysis, the bandwidth limit control can be used to reject frequencies above 20 MHz. Taking the Channel 1 for example, the operation steps are shown as below:

- (1) Press the **CH1 MENU** button to call out the **CH1 SETUP** menu.
- (2) Press the **H4** button and the **Limit** menu will display.
- (3) Press the **F1** button to select the Band Limit as **full band**. The high frequency of the signal will be allowed to pass.
- (4) Press the **F2** button to select the Band Limit as **20M**.The bandwidth is limited to 20MHz.The frequencies above 20 MHz will be rejected.

### Implementation of Mathematical Manipulation Function

The **Mathematical Manipulation** function is used to show the results of the addition, multiplication, division, subtraction operations and the FFT operation between Channel 1 and Channel 2.

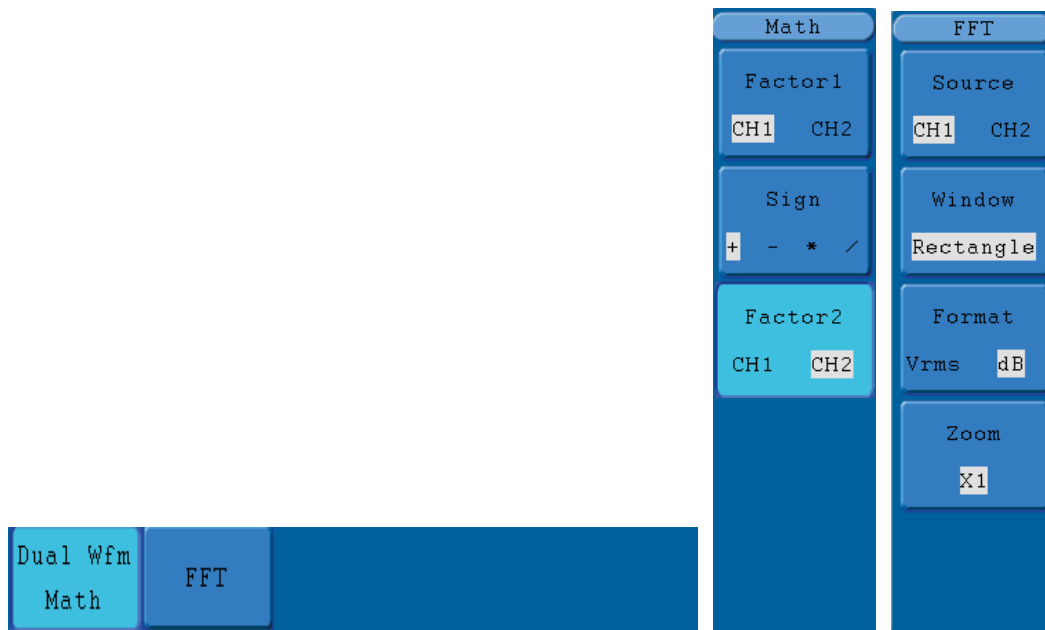

**Fig. 5-6 Wave math menu**

The corresponding FCL (Functional Capabilities List) of the **Waveform Calculation**

Function Menu		Setting	Description
Dual Wfm Math	Factor1	CH1 CH2	Select the signal source of the factor1
	Sign	+ - * /	Select the sign of mathematical manipulation
	Factor 2	CH1 CH2	Select the signal source of the factor2
FFT	Source	CH1	Select CH1 as FFT source.

		CH2	Select CH2 as FFT source.
	Window	Rectangle Blackman Hanning Hamming	Select window for FFT.
	Format	dB Vrms	Select dB for Format. Select Vrms for Format.
	Zoom	×1 ×2 ×5 ×10	Set multiple ×1. Set multiple ×2. Set multiple ×5. Set multiple ×10.

Taking the additive operation between Channel 1 and Channels 2 for example, the operation steps are as follows:

1. Press the **Math** button and call out the **Wfm Math** menu.
2. Press the **H1** button and call out the **Dual Wfm Math** menu. The menu will display at the left of the screen.
3. Press the **F1** menu selection button and choose **CH1** for Factor1.
4. Press the **F2** menu selection button and choose +.
5. Press the **F3** menu selection button and choose **CH2** for Factor2. The green calculated waveform M is displayed in the screen.

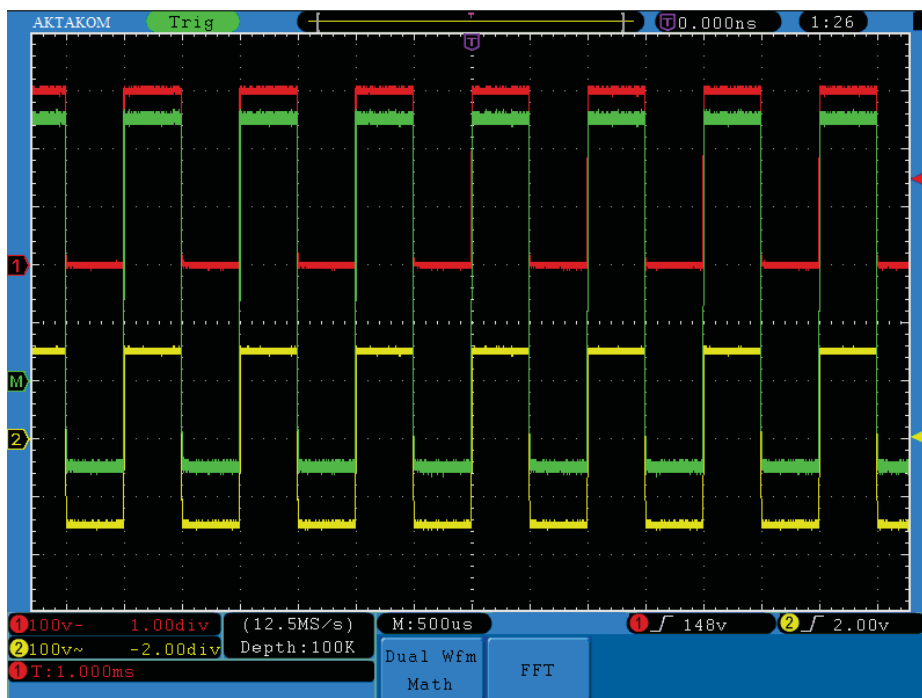

**Fig. 5-7** Waveform resulted from CH1 +CH2 Mathematical Manipulation  
User Manual of Smart Digital Storage Oscilloscope



---

## Using FFT function

An FFT breaks down signals into component frequencies, which the oscilloscope uses to display a graph of the frequency domain of a signal, as opposed to the oscilloscope's standard time domain graph. You can match these frequencies with known system frequencies, such as system clocks, oscillators, or power supplies.



FFT in this oscilloscope can transform 2048 points of the time-domain signal into its frequency components and the final frequency contains 1024 points ranging from 0Hz to Nyquist frequency.

Taking the FFT operation for example, the operation steps are as follows:

1. Press the **Math** button and call out the Math menu.
2. Press the **H2** button and call out the **FFT** menu.
3. Press the **F1** button to choose **CH1** as the source.
4. Press **F2** button, the windows item will display at the left of the screen, turn the **M** knob to select **Window**, including Rectangle、Hamming、Hamming and Blackman.
5. Press **F3** button to choose the Format, including dB, Vrms.
6. Press **F4** button, the zoom window will display at the left of the screen, turn the **M** knob to zoom in or out the wave of the multiple including  $\times 1$ ,  $\times 2$ ,  $\times 5$ ,  $\times 10$ .

### Selecting the FFT Window

■ The FFT feature provides four windows. Each one is a trade-off between frequency resolution and magnitude accuracy. What you want to measure and your source signal characteristics help you to determine which window to use. Use the following guidelines to select the best window.

Type	Description	Window
Rectangle	<p>This is the best type of window for resolving frequencies that are very close to the same value but worst for accurately measuring the amplitude of those frequencies. It is the best type for measuring the frequency spectrum of no repetitive signals and measuring frequency components near DC.</p> <p>Use rectangle for measuring transients or bursts where the signal level before and after the event are nearly equal. Also, use this window for equal-amplitude sine waves with frequencies that are very close and for broadband random noise with a relatively slow varying spectrum.</p>	
Hamming	<p>This is a very good window for resolving frequencies that are very close to the same value with somewhat improved amplitude accuracy over the rectangle window. It has a slightly better frequency resolution than the Hamming.</p>	



	Use Hamming for measuring sine, periodic and narrow band random noise. This window works on transients or bursts where the signal levels before and after the event are significantly different.	
Hamming	This is a very good window for measuring amplitude accuracy but less so for resolving frequencies.  Use Hamming for measuring sine, periodic and narrow band random noise. This window works on transients or bursts where the signal levels before and after the event are significantly different.	
Blackman	This is the best window for measuring the amplitude of frequencies but worst at resolving frequencies.  Use Blackman-Harris for measuring predominantly single frequency waveforms to look for higher order harmonics.	

Fig.5-8, 5-9, 5-10, 5-11 show four kinds of window function referring to sine wave of 1KHz:

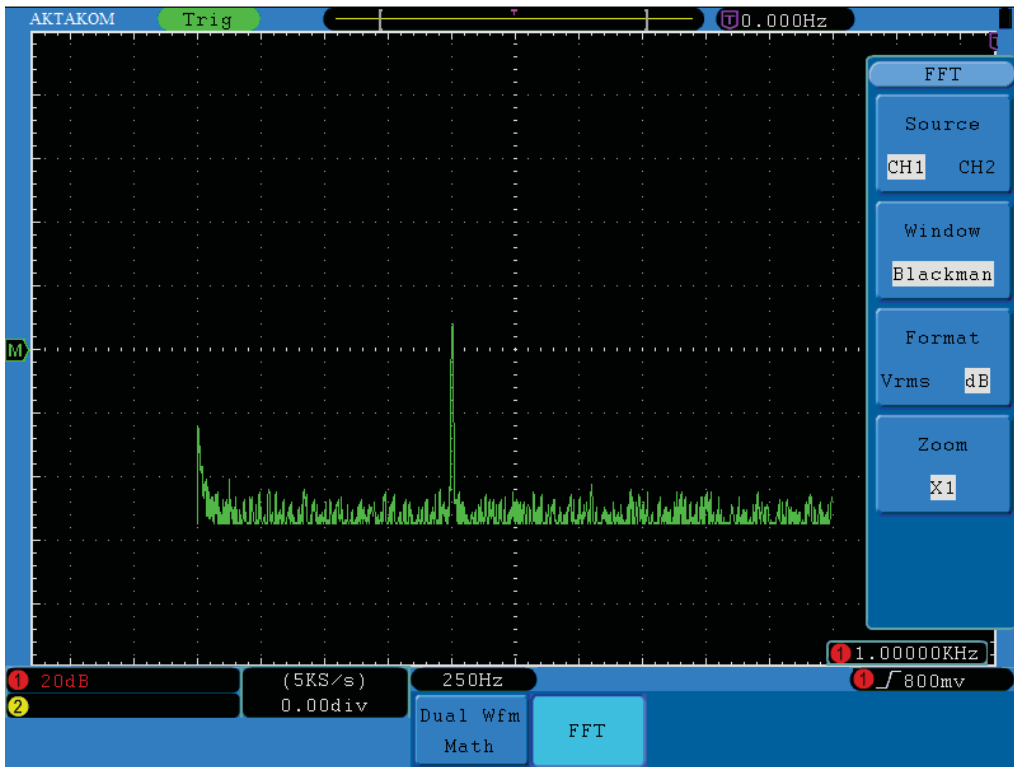

Fig.5-8. Blackman window

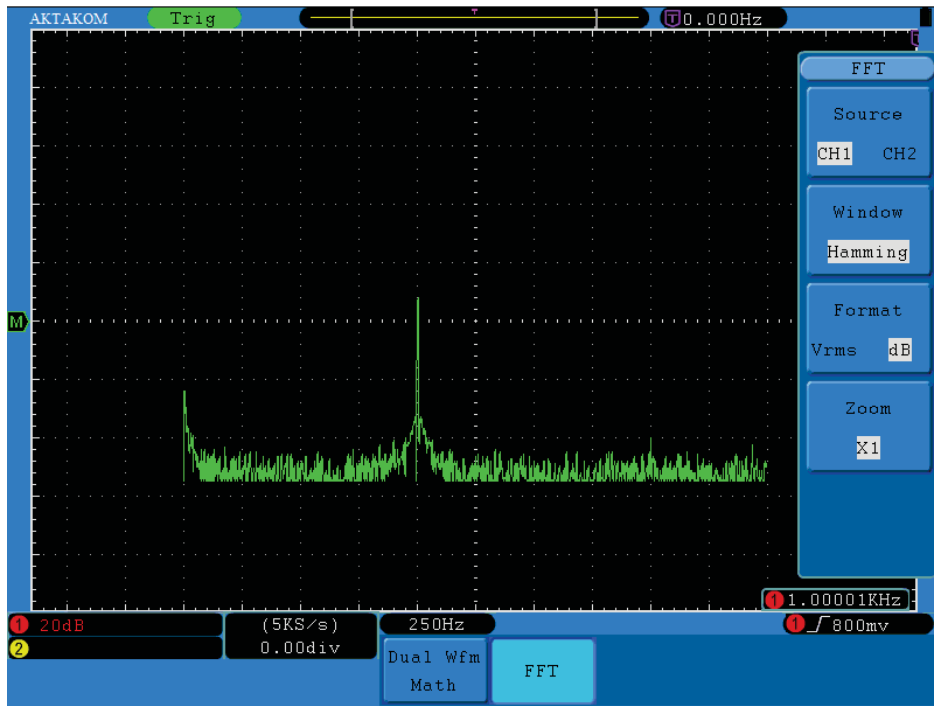

Fig.5-9 Hamming window

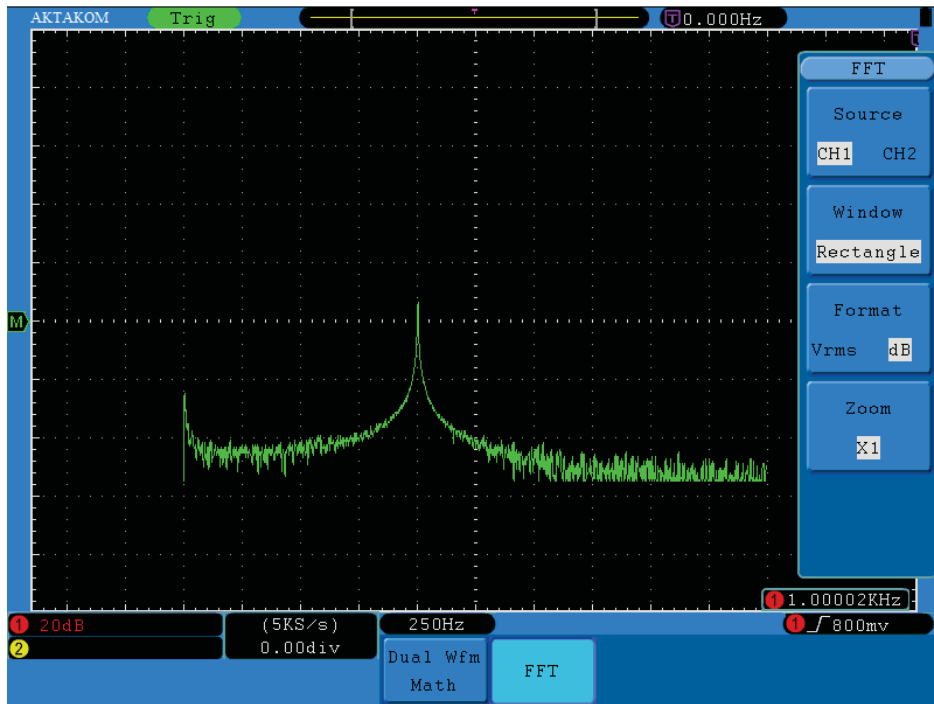

Fig.5-10. Rectangle window

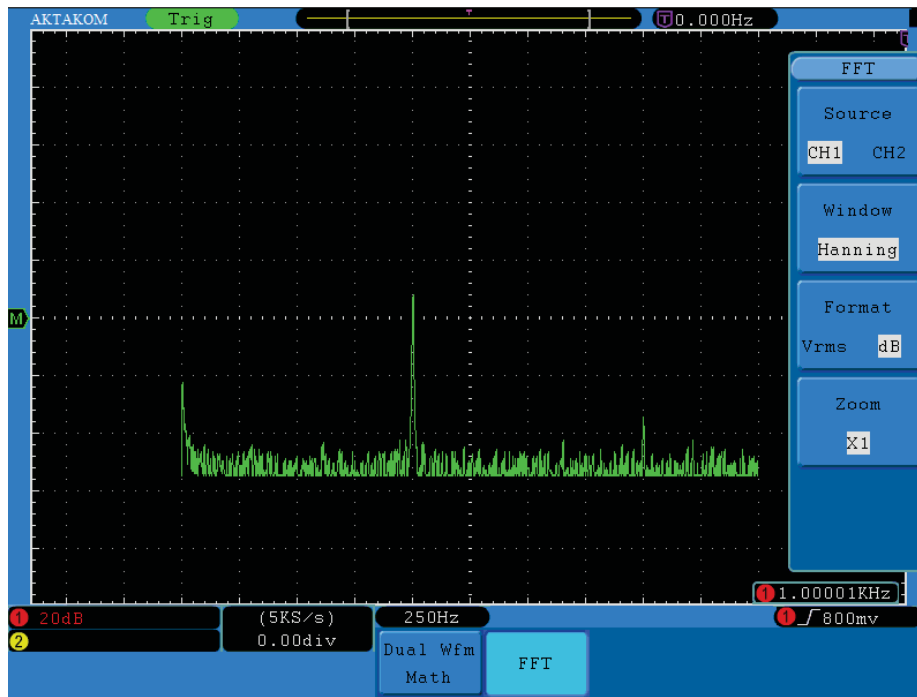

Fig.5-11 Hamming window

### Quick Tips

- If desired, use the zoom feature to magnify the FFT waveform.
- Use the default **dB** scale to see a detailed view of multiple frequencies, even if they have very different amplitudes. Use the **Vrms** scale to see an overall view of how all frequencies compare to each other.
- Signals that have a DC component or offset can cause incorrect FFT waveform component magnitude values. To minimize the DC component, choose AC Coupling on the source signal.
- To reduce random noise and aliased components in repetitive or single-shot events, set the oscilloscope acquisition mode to average.

### Term interpretation

**Nyquist frequency:** The highest frequency that any Real Time Digital Oscilloscope can measure is exactly half of the sampling rate under the condition of no mistakes, which is called Nyquist frequency. If under-sampling occurs when the frequency sampled is higher than Nyquist frequency, “False Wave” phenomenon will appear. So pay more attention to the relation between the frequency being sampled and measured.

### Note:

In FFT mode, the following settings are prohibited:

- 1) Window set;
- 2) XY Format in Display SET;
- 3) “SET 50%” (the triggering level at the vertical point of signal amplitude) in Trigger setting;
- 4) Measure.

---

## Application of VERTICAL POSITION and VOLTS/DIV Knobs

1. The **VERTIVAL POSITION** knob is used to adjust the vertical positions of the waveforms of all Channels (including those resulted from the mathematical operation).  
The analytic resolution of this control knob changes with the vertical division.
2. The **VOLTS/DIV** knob is used to regulate the vertical resolution of the wave forms of all channels (including those obtained from the mathematical manipulation), which can determine the sensitivity of the vertical division with the sequence of 1-2-5. The vertical sensitivity goes up when the knob is rotated clockwise and goes down when the knob is rotated anticlockwise.
3. When the vertical position of the channel waveform is adjusted, the screen shows the information concerning the vertical position at the lower left corner (see Fig.5-12).

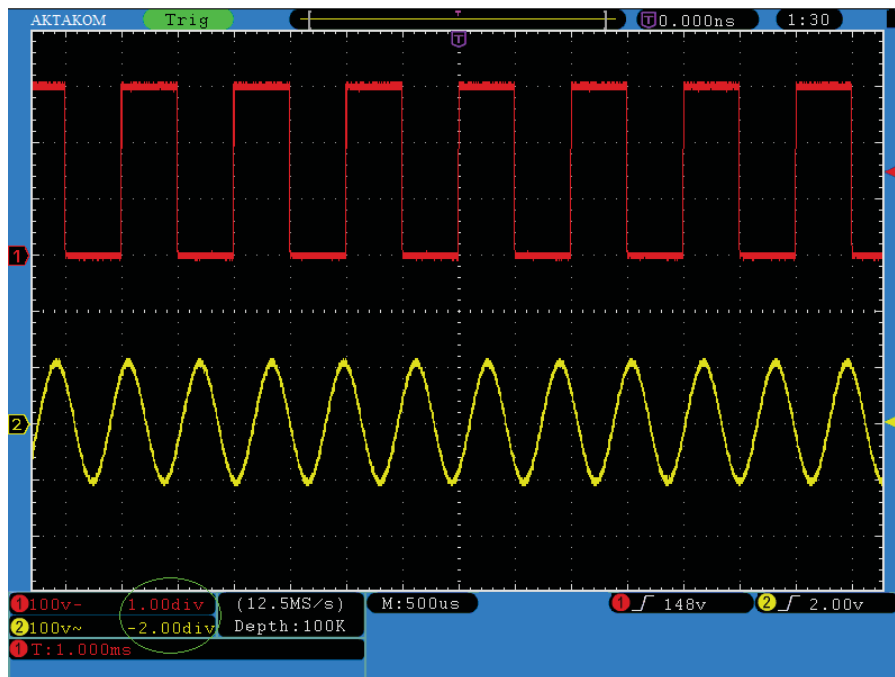

Fig. 5-12 Information about Vertical Position

## How to Set the Horizontal System

The **HORIZONTAL CONTROLS** includes the **HORIZ MENU** button and such knobs as **HORIZONTAL POSITION** and **SEC/DIV**.

1. **HORIZONTAL POSITION** knob: this knob is used to adjust the horizontal positions of all channels (include those obtained from the mathematical manipulation), the analytic resolution of which changes with the time base.
2. **SEC/DIV** knob: it is used to set the horizontal scale factor for setting the main

time base or the window.

3. **HORIZ MENU** button: with this button pushed down, the screen shows the operating menu (see Fig. 5-13).

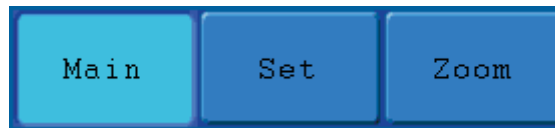

**Fig. 5-13** Time Base Mode Menu

The description of the **Horizontal Menu** is as follows:

Function Menu	Description
Main (Main Time Base)	The setting of the horizontal main time base is used to display the waveform.
Set (Set Window)	A window area is defined by two cursors. This function is not available at FFT mode.
Zoom (Zoom Window)	The defined window area for display is expanded to the full screen.

## Main Time Base

Press the **H1** menu selection button and choose **Main** . In this case, the **HORIZONTAL POSITION** and **SEC/DIV** knobs are used to adjust the main window. The display in the screen is shown as Fig.5-14

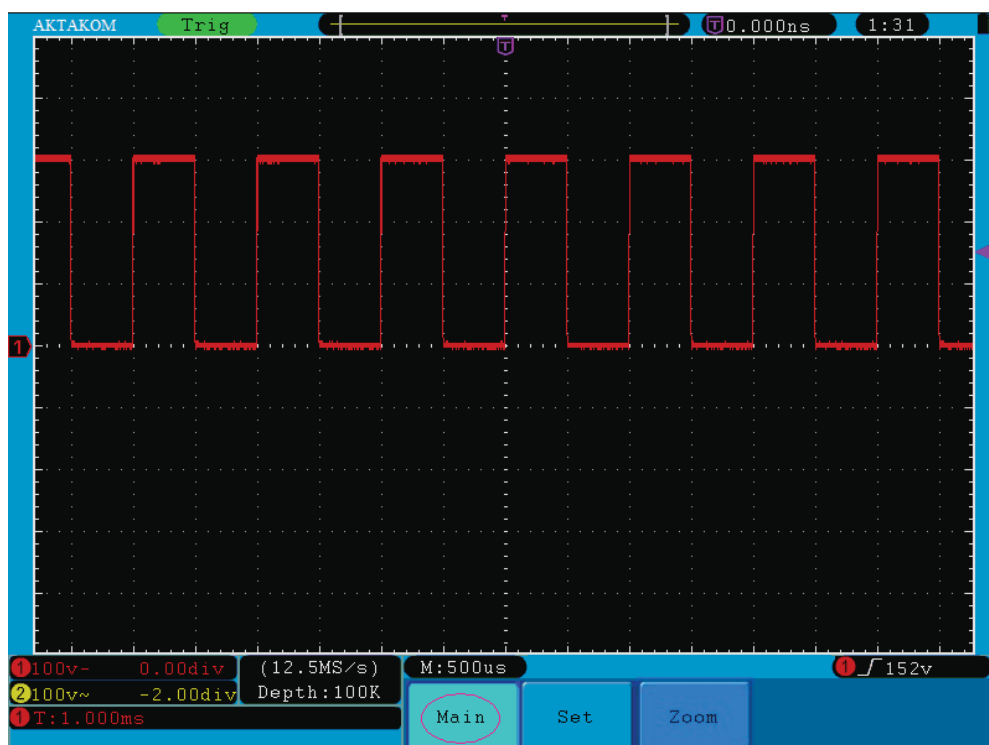

**Fig. 5-14** Main Time Base

## Set Window

Press the **H2** menu selection button and choose **Set**. The screen will show a window

area defined by two cursors. In this case, the **HORIZONTAL POSITION** and **SEC/DIV** knobs can be used to adjust the horizontal position and size of this window area. In FFT mode, **Set** menu is invalid. See Fig.5-15.

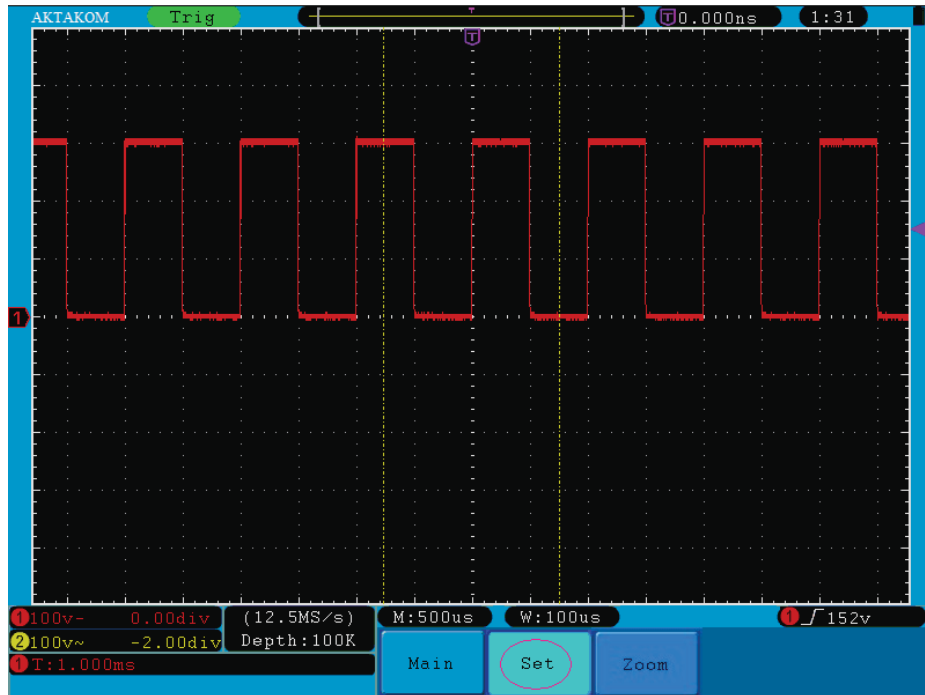

Fig. 5-15 Window Setting

## Window Expansion

Press the **H3** menu selection button and choose **Zoom**. As a result, the window area defined by two cursors will be expanded to the full screen size (see Fig. 5-16).

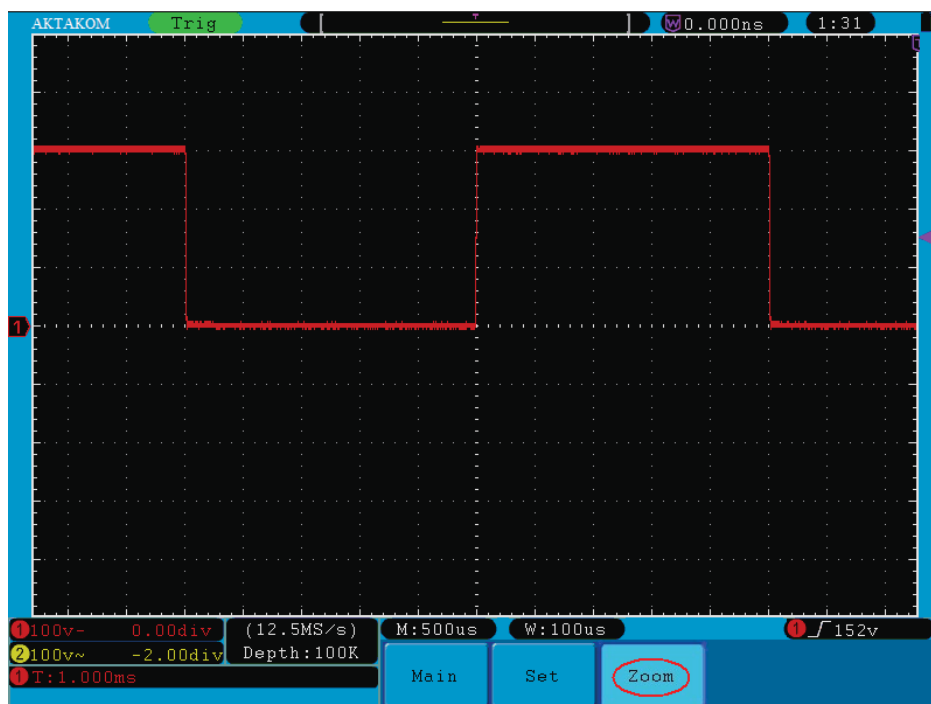

Fig. 5-16 Zoom Window

---

## How to set the Trigger System

Trigger is to determine when DSO starts to acquire data and waveform display. Once trigger to be set correctly then it will convert the unstable display to meaning waveform.

When DSO start to acquire data it will acquire enough data to form waveform on left of trigger point. DSO continues to acquire data when it waits for trigger condition happen. Once it detect out the trigger it will acquire enough data continuously to form the waveform on right of trigger point.

Trigger control area consists of 1 knob and 3 menu keys.

**TRIG LEVEL:** The knob that set the trigger level; press the knob and the level will be cleaned to Zero.

**50%:** The instant execute button setting the trigger level to the vertical midpoint between the peaks of the trigger signal.

**Force:** Force to create a trigger signal and the function is mainly used in “Normal” and “Single” mode.

**Trigger Menu:** The button that activates the trigger control menu.

### Trigger Control

The oscilloscope provides two trigger types: single trigger and alternate trigger.

**Single trigger:** Use a trigger level to capture stable waveforms in two channels simultaneously.

**Alternate trigger:** Trigger on non-synchronized signals.

The **Single Trigger** and **Alternate Trigger** menus are described respectively as follows:

#### Single trigger

Single trigger has four modes: edge trigger, video trigger, pulse trigger and slope trigger.

**Edge Trigger:** It happens when a specified voltage level passes through the trigger input in the specified slope direction.

**Video Trigger:** Carry out field or line video trigger on the standard video signal.

**Pulse Trigger:** Use this trigger type to catch pulses with certain pulse width.

**Slope Trigger:** The oscilloscope begins to trigger according to the signal rising or falling speed.

The four trigger modes in Single Trigger are described respectively as follows:

#### 1. Edge Trigger

An edge trigger occurs on trigger threshold value of input signal. Select Edge trigger mode to trigger on rising edge, falling edge or rising & falling edge.



The Edge Trigger Menu is shown as Fig.5-17

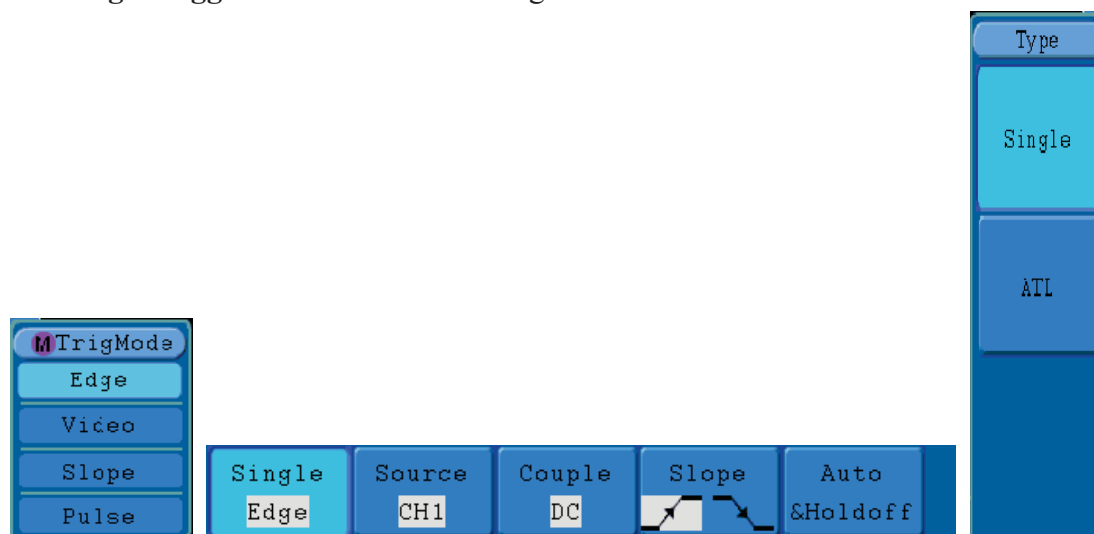



Fig. 5-17 Edge trigger menu

Edge menu list:

MENU	SETTINGS	INSTRUCTION
Single Mode	Edge	Set vertical channel trigger type as edge trigger.
Source	CH1	Select CH1 as trigger signal.
	CH2	Select CH2 as trigger signal.
	EXT	Select Ext-trigger as trigger signal
	EXT/5	Select attenuated Ext TRIG/5 as trigger signal.
	AC Line	Select power line as trigger signal.
Couple	AC	Not allow DC portion to pass.
	DC	Allow all portion pass.
	HF	Not allow high frequency of signal pass and only low frequency portion pass.
	LF	Not allow low frequency of signal pass and only high frequency portion pass.
Slope		Trigger in signal rising edge
		Trigger in signal falling edge
Mode	Auto	Acquire waveform even no trigger occurred
	Normal	Acquire waveform when trigger occurred
	Single	When trigger occurs, acquire one waveform then stop
	Holdoff	100ns~10s, adjust <b>M</b> knob to set time interval before another trigger occur.
Reset	Set Holdoff time as 100ns	

## 2. Video Trigger

Choose video trigger to trigger on fields or lines of NTSC, PAL, or SECAM standard video signals.

Trig menu refer to Fig.5-18

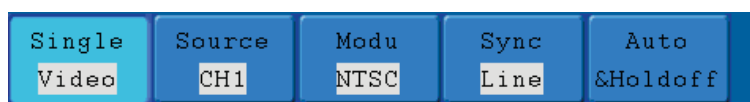

Fig. 5-18 Video trigger menu

Video menu list:

MENU	SETTING	INSTRUCTION
Single Mode	Video	Set vertical channel trigger type as video trigger.
Source	CH1	Select CH1 as the trigger source.
	CH2	Select CH2 as the trigger source.
	EXT	The external trigger input.
	EXT/5	Ext-trigger divided to 5 to extend trigger level range.
Modu	NTSC	Select video modulation
	PAL	
	SECAM	
Sync	Line	Synchronic trigger in video line.
	Field	Synchronic trigger in video field.
	Odd	Synchronic trigger in video odd filed
	Even	Synchronic trigger in video even field
	Line NO.	Synchronic trigger in designed video line, turn the <b>M</b> knob to set the line number
Mode	Auto	Acquire waveform even no trigger occurred 100ns~10s, adjust the <b>M</b> knob to set time interval before another trigger occur.
	Holdoff	
Holdoff	Reset	Set Holdoff time as 100ns

### 3. Pulse Width Trigger

Pulse trigger occurs according to the width of pulse. The abnormal signals can be detected through setting up the pulse width condition.

The **Pulse Width Trigger Menu** is shown as **Fig. 5-19**.

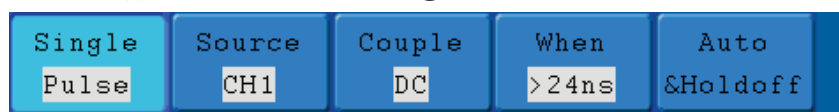

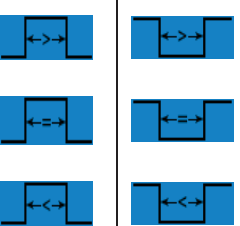

Fig. 5-19 Pulse Width Trigger menu

Pulse Width Trigger menu list

MENU	SETTING	INSTRUCTION
Single Mode	Pulse	Set vertical channel trigger type as pulse trigger.
Source	CH1	Select CH1 as the trigger source.
	CH2	Select CH2 as the trigger source.
Coupling	AC	Not allow DC portion to pass.
	DC	Allow all portion pass.
	HF	Not allow high frequency of signal pass and only low frequency portion pass.
	LF	Not allow low frequency of signal pass and only high frequency portion pass

when	<p>Polarity</p> 	Choose the polarity
		Select pulse width condition and adjust the <b>M</b> knob to set time.
Mode Holdoff	Auto Normal Single Holdoff  Reset	Acquire waveform even no trigger occurred Acquire waveform when trigger occurred When trigger occurs, acquire one waveform then stop 100ns~10s, adjust <b>M</b> knob to set time interval before another trigger occur. Set Holdoff time as 100ns

#### 4. Slope Trigger

Slope trigger sets the oscilloscope as the positive/negative slope trigger within the specified time.

The **Slope Trigger Menu** is shown as **Fig. 5-20**.

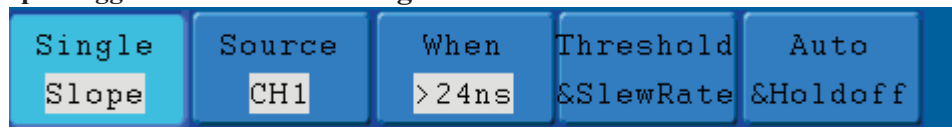

**Fig. 5-20** Slope trigger menu

Slope trigger menu list

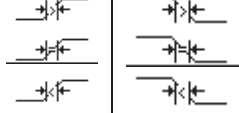
MENU	SETTING	INSTRUCTION
Single Mode	Slope	Set vertical channel trigger type as slope trigger.
Source	CH1 CH2 EXT EXT/5 AC Line	Select CH1 as the trigger source. Select CH2 as the trigger source. Ext-trigger Ext-trigger divide to 5 to extend trigger level range AC Line as resource trigger signal.
When	<p>slope</p> 	Slope selecting
		Set slope condition, turn the <b>M</b> knob to set slope time.
Threshold	High level Low level Slew rate	Adjust <b>M</b> knob to set the High level upper limit. Adjust <b>M</b> knob to set Low level lower limit. Slew rate=( High level- Low level)/ Settings
Mode	Auto Normal	Acquire waveform even no trigger occurred Acquire waveform when trigger occurred

Holdoff	Single Holdoff	When trigger occurs, acquire one waveform then stop 100ns~10s, turn the <b>M</b> knob to set time interval before another trigger occur.
	Reset	Set Holdoff time as 100ns

## Alternate trigger

Trigger signal comes from two vertical channels when alternate trigger is on. This mode is used to observe two unrelated signals. You can choose different trigger modes for different channels. The options are as follows: edge, video, pulse or slope.



### 1. Alternate trigger (Trigger mode: Edge)

Alternate trigger (Trigger Type: Edge) Menu is shown as Fig.5-21.



Fig.5-21 Alternate trigger (Trigger Type: Edge) Menu

Alternate trigger(Trigger Type: Edge) Menu list:

MENU	SETTING	INSTRUCTION
Alternate Mode	Edge	Set vertical channel trigger type as edge trigger.
Source	CH1 CH2	Select CH1 as the trigger source. Select CH2 as the trigger source.
Couple	AC DC HF LF	Not allow DC portion to pass. Allow all portion pass. Not allow high frequency of signal pass and only low frequency portion pass. Not allow low frequency of signal pass and only high frequency portion pass.
Slope	 	Trigger in signal rising edge Trigger in signal falling edge
Mode	Auto	Acquire waveform even no trigger occurred
Holdoff	Holdoff Reset	100ns~10s, adjust <b>M</b> knob to set time interval before another trigger occur. Set Holdoff time as 100ns

## 2. Alternate trigger (Trigger Mode: video)

Alternate trigger (Trigger Type: video) Menu is shown as Fig.5-22.

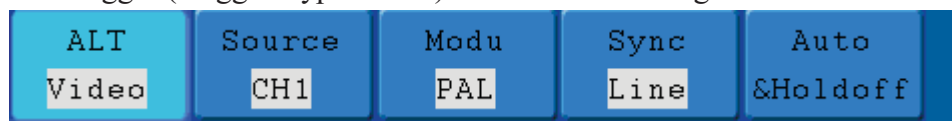

Fig.5-22 Alternate trigger (Trigger Type: video) Menu

Alternate trigger (Trigger Type: video) Menu list:

MENU	SETTING	INSTRUCTION
Alternate Mode	Video	Set vertical channel trigger type as video trigger.
Source	CH1 CH2	Select CH1 as the trigger source. Select CH2 as the trigger source.
Modu	NTSC PAL SECAM	Select video modulation
Sync	Line Field Odd Field Even Field Line NO.	Synchronic trigger in video line. Synchronic trigger in video field. Synchronic trigger in video odd filed Synchronic trigger in video even field Synchronic trigger in designed video line, turn the <b>M</b> knob to set the line number
Mode	Auto Holdoff	Acquire waveform even no trigger occurred 100ns~10s, adjust the <b>M</b> knob to set time interval before another trigger occur.
Holdoff	Reset	Set Holdoff time as 100ns

## 3. Alternate trigger (Trigger Mode: Pulse)

Alternate trigger (Trigger Type: Pulse) Menu is shown as Fig.5-23.

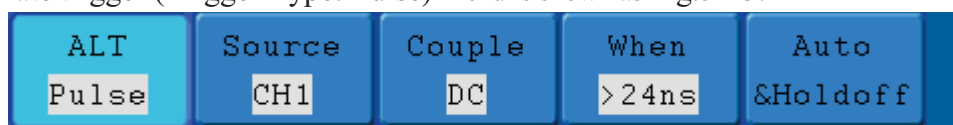

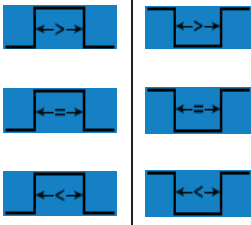

Fig.5-23 Alternate trigger (Trigger Type: Pulse) Menu

Alternate trigger (Trigger Type: Pulse) menu list

MENU	SETTING	INSTRUCTION
Alternate Mode	Pulse	Set vertical channel trigger type as pulse trigger.
Source	CH1 CH2	Select CH1 as the trigger source. Select CH2 as the trigger source.
Coupling	AC DC HF LF	Not allow DC portion to pass. Allow all portion pass. Not allow high frequency of signal pass and only low frequency portion pass. Not allow low frequency of signal pass and only high

		frequency portion pass.
when	Polarity 	Choose the polarity
		Select pulse width condition and turn the <b>M</b> knob to set time.
	Auto Holdoff Reset	Acquire waveform even no trigger occurred 100ns~10s, adjust <b>M</b> knob to set time interval before another trigger occur. Set Holdoff time as 100ns

#### 4. Alternate trigger (Trigger Mode: Slope )

Alternate trigger (Trigger Type: Slope) Menu is shown as Fig.5-24.

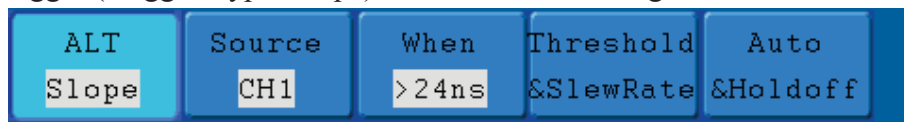

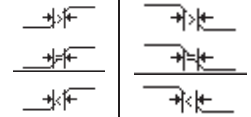

Fig.5-24 Alternate trigger (Trigger Type: Slope ) Menu

Alternate trigger (Trigger Type: Slope) menu list:

MENU	SETTING	INSTRUCTION
Alternate Mode	Slope	Set vertical channel trigger type as slope trigger.
Source	CH1 CH2	Select CH1 as the trigger source. Select CH2 as the trigger source.
When	slope 	Select slope condition
		Set slope condition, turn the <b>M</b> knob to set time.
Threshold	High level	Turn <b>M</b> knob to set the High level
	Low level	Turn <b>M</b> knob to set Low level
	Slew rate	$Slew\ rate = (High\ level - Low\ level) / Settings$
Mode	Auto	Acquire waveform even no trigger occurred
	Holdoff	100ns~10s, adjust the <b>M</b> knob to set time interval before another trigger occur.
Holdoff	Reset	Set Holdoff time as 100ns

#### Term interpretation

1. **Source:** Trigger can occur from several sources: Input channels (CH1, CH2), AC Line, Ext, Ext/5.

● **Input:** It is the most commonly used trigger source. The channel will work when

---

selected as a trigger source whatever displayed or not.

- **Ext Trig:** The instrument can trigger from a third source while acquiring data from CH1 and CH2. For example, you might want to trigger from an external clock or with a signal from another part of the test circuit. The Ext, Ext/ 5 trigger sources use the external trigger signal connected to the EXT TRIG connector. Ext uses the signal directly; it has a trigger level range of +1.6 V to -1.6 V. The EXT/ 5 trigger source attenuates the signal by 5X, which extends the trigger level range to +8 V to -8 V. This allows the oscilloscope to trigger on a larger signal
- **AC Line:** AC power can be used to display signals related to the power line frequency, such as lighting equipment and power supply devices. The oscilloscope gets triggered on its power cord, so you do not have to input an AC trigger signal. When AC Line is selected as trigger source, the oscilloscope automatically set coupling to DC, set trigger level to 0V.

## 2. Trigger Mode:

The trigger mode determines how the oscilloscope behaves in the absence of a trigger event. The oscilloscope provides three trigger modes: Auto, Normal, and Single.

- **Auto:** This sweep mode allows the oscilloscope to acquire waveforms even when it does not detect a trigger condition. If no trigger condition occurs while the oscilloscope is waiting for a specific period (as determined by the time-base setting), it will force itself to trigger.
- **Normal:** The Normal mode allows the oscilloscope to acquire a waveform only when it is triggered. If no trigger occurs, the oscilloscope keeps waiting, and the previous waveform, if any, will remain on the display. Single: In Single mode, after pressing the **Run/Stop** key, the oscilloscope waits for trigger. While the trigger occurs, the oscilloscope acquires one waveform then stop.
- **Single:** In Single mode, after pressing the **Run/Stop** key, the oscilloscope waits for trigger. While the trigger occurs, the oscilloscope acquires one waveform then stop.

## 3. Coupling:

Trigger coupling determines what part of the signal passes to the trigger circuit.

Coupling types include AC, DC, LF Reject and HF Reject.

- **AC:** AC coupling blocks DC components.
- **DC:** DC coupling passes both AC and DC components.
- **LF Reject:** LF Reject coupling blocks DC component, and attenuates all signal with a frequency lower than 8 kHz.
- **HF Reject:** HF Reject coupling attenuates all signals with a frequency higher than 150 kHz.

**4. Holdoff:** A time interval before the oscilloscope responses to next trigger signal. During this Holdoff period, the trigger system becomes “blind” to trigger signals. This function helps to view complex signals such as an AM waveform. Press Holdoff button to activate “**TRIG LEVEL**” knob, then turn it to adjust Holdoff time.

## How to Operate the Function Menu

The function menu control zone includes 9 function menu buttons and 3 immediate-execution buttons: **Measure**, **Acquire**, **Autoset**, **Utility**, **Cursor**, **Autoscale**, **Save**, **Display**, **Help**, **Run/Stop**, **Copy** and **Single**.

### How to Implement Sampling Setup

Press the **Acquire** button and the menu is displayed in the screen, shown as Fig.5-25.

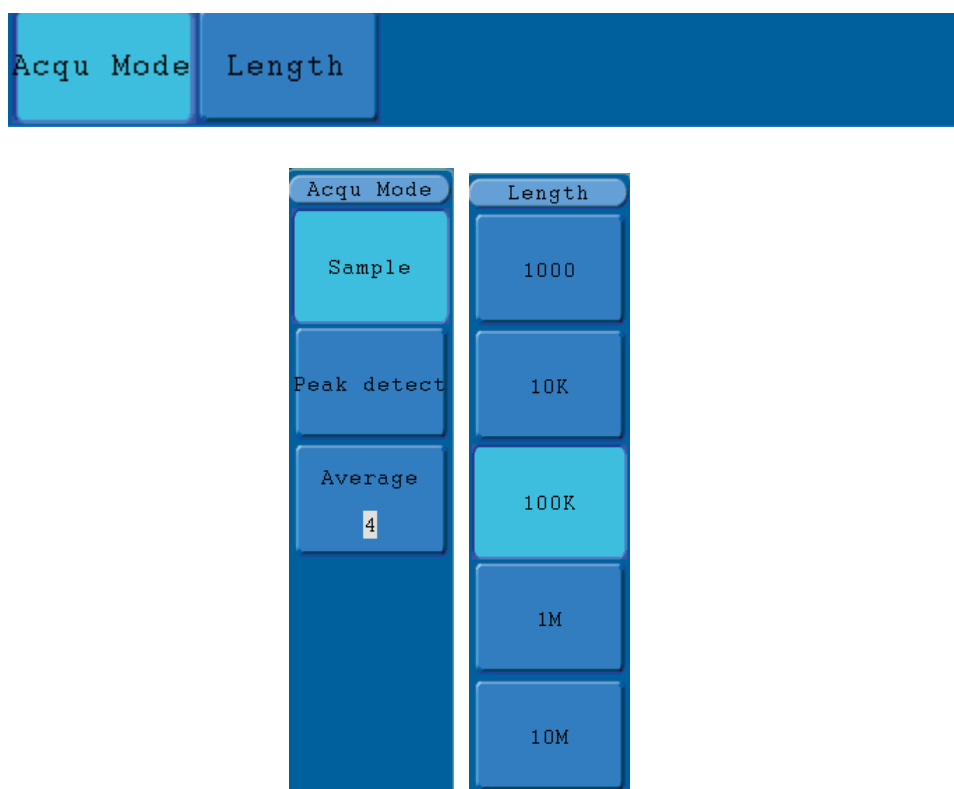

**Fig.5-25 ACQU MODE Menu**

The description of the **Acqu Mode Menu** is shown as follows:

Function Menu	Setting	Description
Sample	Sample	General sampling mode.
	Peak Detect	It is used for the detection of the jamming burr and the possibility of reducing the confusion.
	Averages	4, 16, 64, 128 It is used to reduce the random and don't-care noises, with the optional number of averages.

The description of the **Record Length Menu** is shown as follows:



Function Menu	Setting	Description
Length	1000	Choose the record length
	10K	
	100K	
	1M	
	10M	

Change the **ACQU Mode** settings and observe the consequent variation of the wave form displayed.

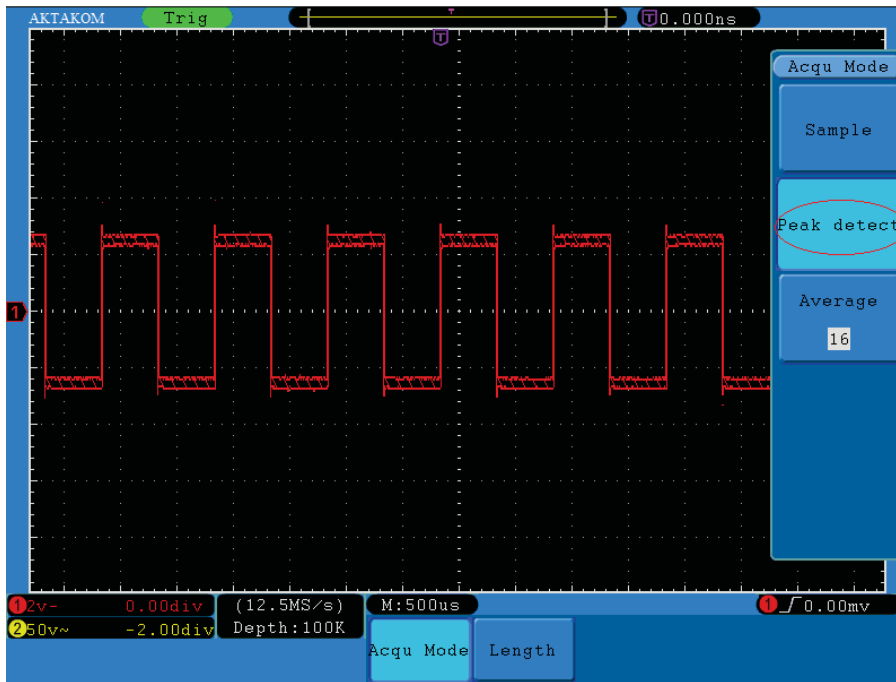

**Fig.5-26** Peak Detect mode, under which the burrs on the falling edge of the square wave, can be detected and the noise is heavy.

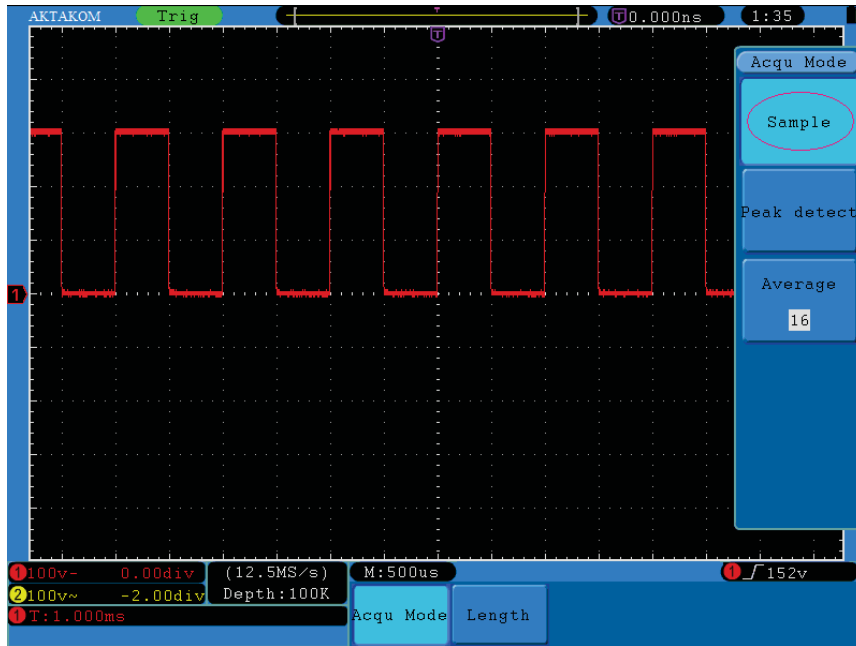

Fig.5-27 Common ACQU Mode display, in which no burr can be detected.

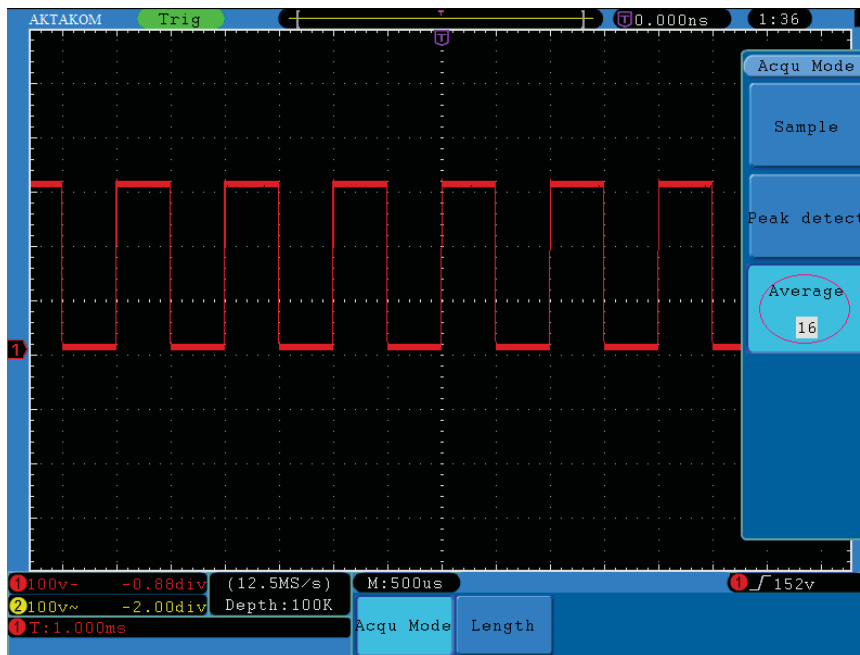

Fig.5-28 The displayed waveform after the noise is removed under the Average Mode, in which the average number of 16 is set.

## How to Set the Display System

Push down the **Display** button and the menu displayed in the screen is shown as Fig.5-29.

Type	Persist	XY Mode	Cymometer	VGA Disp
Dots Vect	OFF	ON OFF	ON OFF	ON OFF

Fig.5-29 Display Set Menu

The description of the **Display Set Menu** is shown as follows:

Function Menu	Setting	Description
Type	Dots Vect	Only the sampling points are displayed. The space between the adjacent sampling points in the display is filled with the vector form.
Persist	Time OFF 1 second 2 seconds 5 seconds Infinity	Turn the <b>M</b> knob to set the persistence time
	Clear	Clear the persistence
XY Mode	ON OFF	Turn on the XY display function; Turn off the XY display function.
Cymometer	ON OFF	Turn on the cymometer ; Turn off the cymometer.
VGA Disp	ON OFF	Connect the VGA port to a monitor. If set it as ON, the waveform could be displayed on the computer monitor.

**Display Type:** With the **F1** menu selection button pushed down, you can shift between **Vect** and **Dots** types. The differences between the two display types can be observed through the comparison between **Fig.5-30** and **Fig.5-31**.

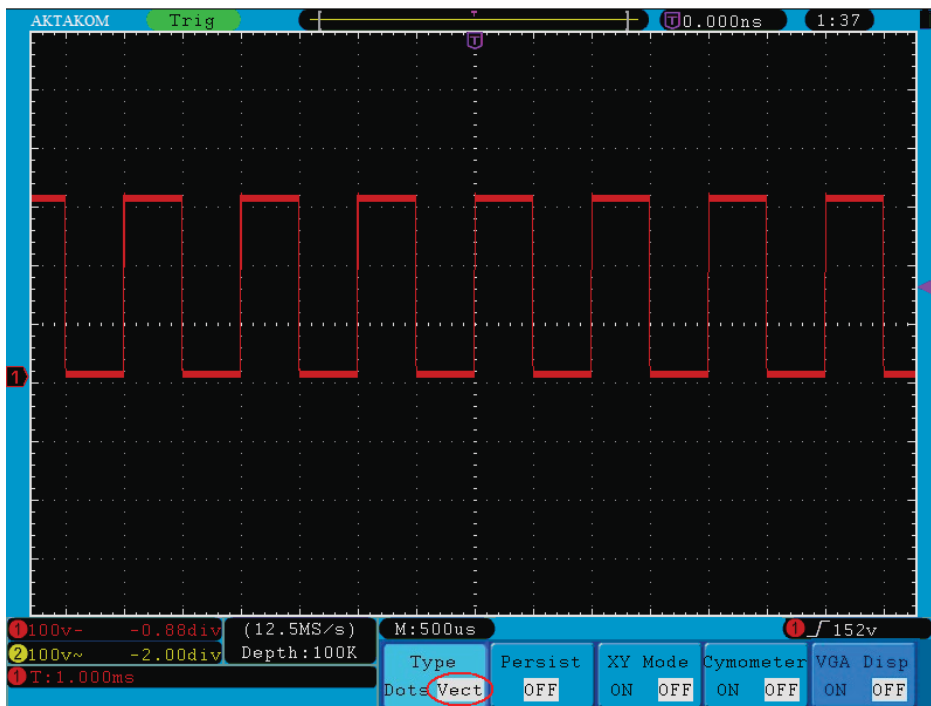

**Fig.5-30** Display in the Vector Form

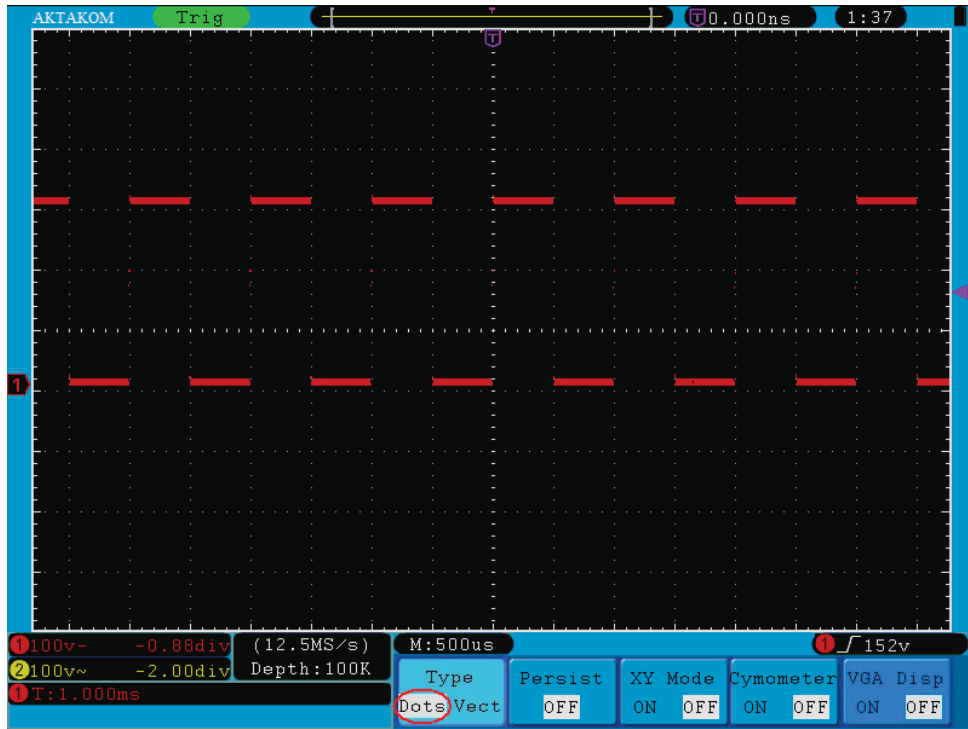
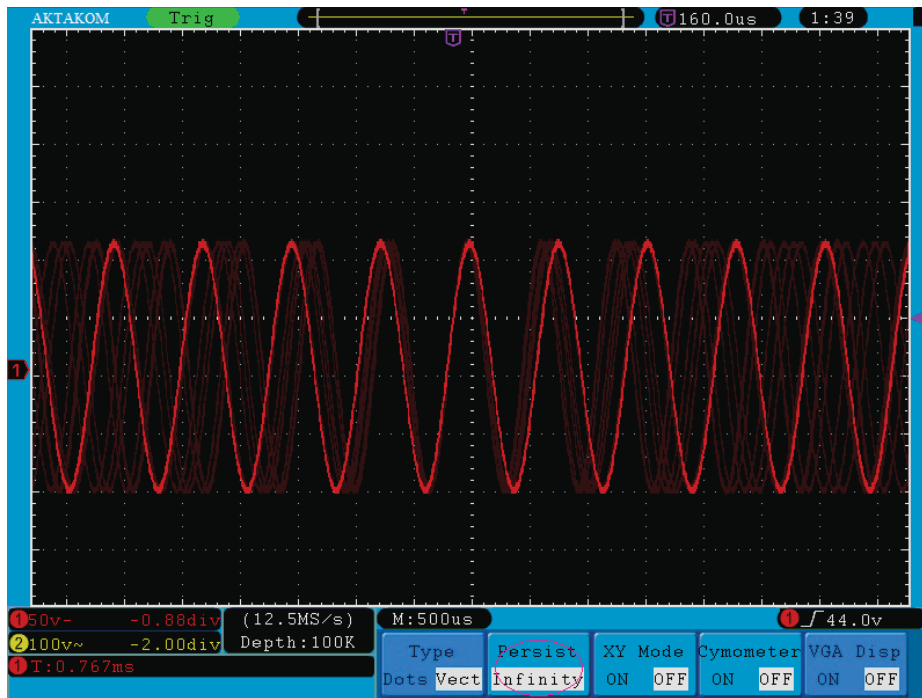

Fig.5-31 Display in Dots form

## Persist

When the **Persist** function is used, the persistence display effect of the picture tube oscilloscope can be simulated: the reserved original data is displayed in fade color and the new data is in bright color. Press the **H2** button, the **Persist** menu will display at the right of screen. Press the **F1** button, different persistence time can be chosen: **OFF**, **1second**, **2second**, **5second** and **Infinity**. When the “**Infinity**” option is set for **Persist** time, the measuring points will be stored till the controlling value is changed (see **Fig.5-34**). By pressing the **F2** button, the persistence will be cleared.



**Fig.5-32** Infinite Persistence Display

## XY Format

This format is only applicable to Channel 1 and Channel 2. After the XY display format is selected, Channel 1 is displayed in the horizontal axis and Channel 2 in the vertical axis; the oscilloscope is set in the un-triggered sample mode: the data are displayed as bright spots and the sampling rate is 1MS/s and cannot be changed.

**The operations of all control knobs are as follows:**

- The Vertical **VOLTS/DIV** and the **VERTICAL POSITION** knobs of Channel 1 are used to set the horizontal scale and position.
- The Vertical **VOLTS/DIV** and the **VERTICAL POSITION** knobs of Channel 2 are used to set the vertical scale and position continuously.

**The following functions cannot work in the XY Format:**

- Reference or digital wave form
- Cursor
- Time base control
- Trigger control
- FFT

Operation steps:

1. Press the **Display** button and call out the **Display Set Menu**.

2. Press the **H3** menu selection button to set XY Mode **ON**. The display format is changed to be XY mode (see **Fig.5-33**).

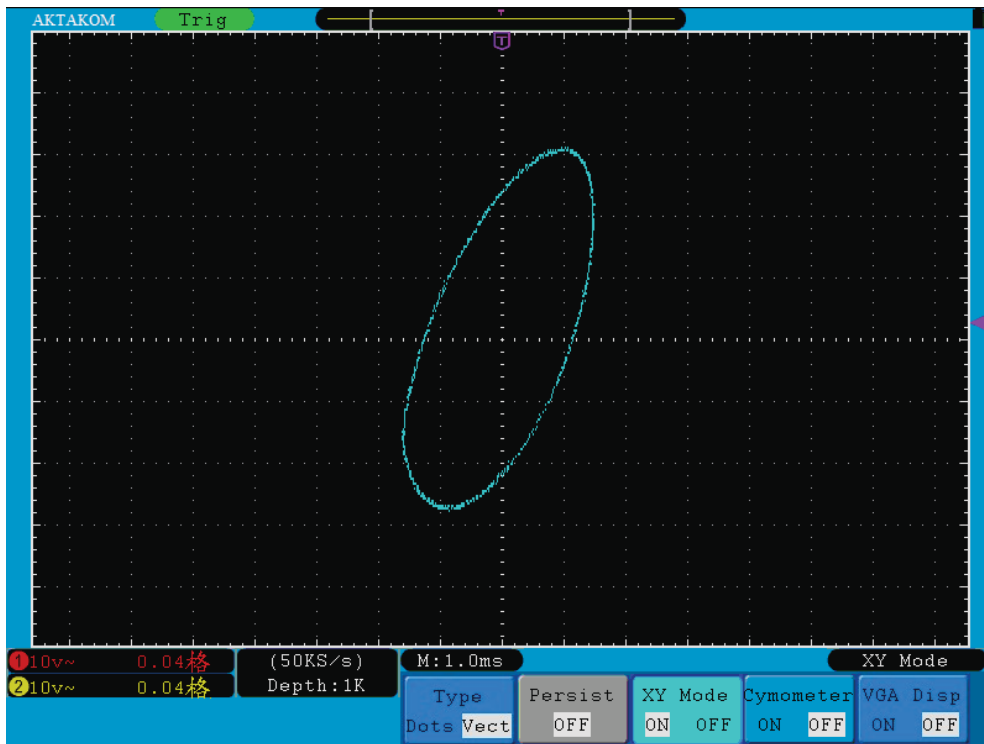

**Fig.5-33** XY Display Mode

## Cymometer

It is a 6-digit cymometer. The cymometer can measure frequencies from 2Hz to the full bandwidth. Only if the measured channel has triggering signal and in **Edge** mode, it can measure frequency correctly. In the **Single** trigger mode, it is a one channel cymometer and it can only measure the frequency of the triggering channel. In the **ALT** trigger mode, it is a two channel cymometer and it can measure the frequency of two channels. The cymometer is displayed at the right bottom of the screen.

To turn the cymometer on or off:

1. Press the **Display** button.
2. In the **Display** menu, press the **H4** button to toggle between the cymometer display **ON** or **OFF**.

## VGA Output

The VGA port could be connected to a computer monitor. The image of the oscilloscope can be clearly displayed on the monitor.

To set the VGA Output:

1. Press the **Display** button.
2. In the **Display** menu, press the **H5** button to toggle between **ON** or **OFF**.

## How to Save and Recall a Waveform

Press the **Save** button, you can save the waveforms and settings in the instrument. The menu displayed in the screen is shown as **Fig.5-34**.

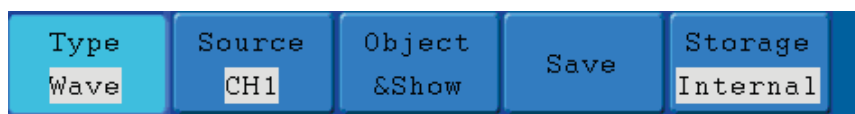

**Fig.5-34** Waveform Save Menu

The description of the **Save Function Menu** is shown as the following table:

Function Menu	Setting	Description	
Type	Wave Setting Image Record	Choose the saving type (the <b>Record</b> Type see “How to Record/Playback Waveforms” on P51)	
When the type is <b>Wave</b> , the menu shows as following:			
Source	CH1 CH2 Math	Choose the waveform to be saved.	
Object & Show	Object	1~15	Choose the address which the waveform is saved to or recall from.
	Show	ON OFF	Recall or close the waveform stored in the current object address. When the show is ON, if the current object address has been used, the stored waveform will be shown, the address number and relevant information will be displayed at the top left of the screen; if the address is empty, “None is saved” will be displayed.
Save		Save the waveform of the source to the selected address. You can also press <b>Copy</b> button to do it. Storage format is vector.	
Storage	Internal External	Save to internal storage of USB storage. When External is selected, save the waveform according to the current record length (see “Record Length Menu” on P42). The file will be named according to the current system time. The waveform file could be open by OWON waveform analysis software (on the supplied CD).	
When the type is <b>Setting</b> , the menu shows as following:			

Setting	Setting1 ..... Setting8	The setting address
Save		Save the current oscilloscope setting to the internal storage
Load		Recall the setting from the selected address
When the type is <b>Image</b> , the menu shows as following:		
Save		Save the current display screen. You can also press <b>Copy</b> button to do it. The file can be only stored in a USB storage, so a USB storage must be connected first. The file is stored in BMP format, named according to the current system time.

## Save and Recall the Waveform

The SDS series oscilloscope can store 15 waveforms, which can be displayed with the current waveform at the same time. The stored waveform called out cannot be adjusted.

In order to save the waveform of the channel CH1 into the address 1, the operation steps should be followed:

1. **Saving:** Press the **H1** button, the **Type** menu will display at the left of screen, turn the **M** knob to choose **Wave** for Type.
2. Press the **H2** button and press **F1** button to select **CH1** for Source.
3. Press the **H3** button, and press the **F1**, turn the **M** knob to select **1** as object address.
4. Press the **H5** button and press **F1** button to select **Internal**.
5. Press the **H4** button to save the waveform.
6. **Recalling:** Press the **H3** button, and press the **F1**, turn the **M** knob to select **1** as object address. Press **F2** button to set **Show** as **ON**. The waveform stored in the address will be shown, the address number and relevant information will be displayed at the top left of the screen.



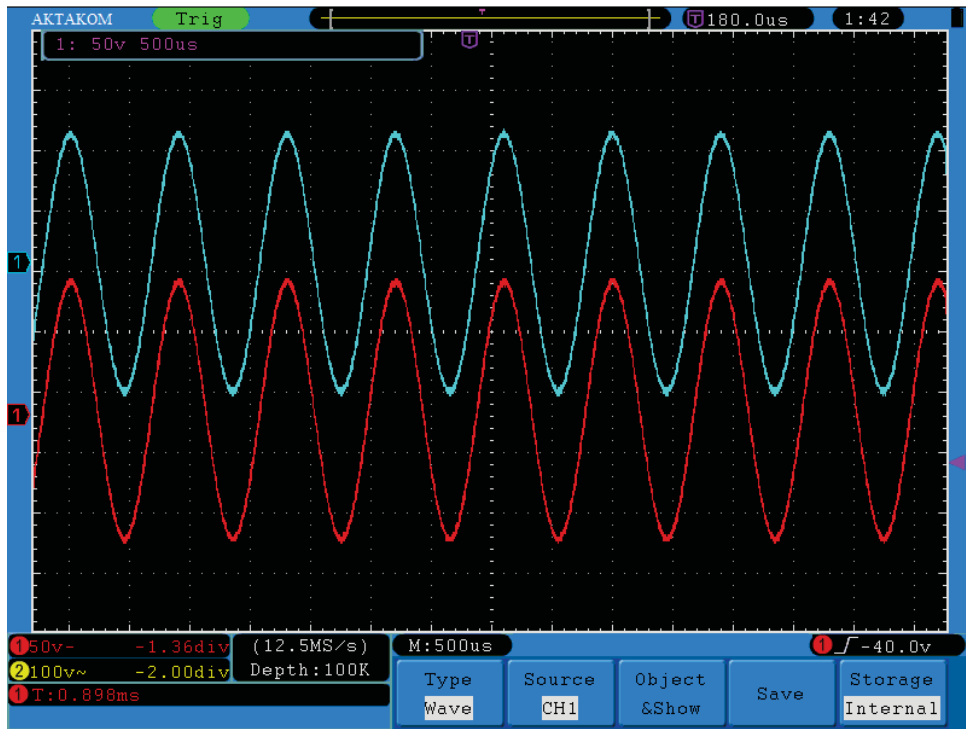

Fig.5-35 Wave Saving

## How to Record/Playback Waveforms

Wave Record function can record the input current wave. You can set the interval between recorded frames in the range of 1ms~1000s. The max frame number reaches 1000, and you can get better analysis effect with playback and storage function.

Wave Record contains four modes: **OFF**, **Record**, **Playback** and **Storage**.

**Record:** To record wave according to the interval until it reaches the end frame set. Record menu shows as follows:

Menu	Setting	Instruction
Mode	OFF	Close wave record function
	Record	Set record menu
	Playback	Set playback menu
	Storage	Set storage menu
Record mode Frame Set	End frame	Turn the <b>M</b> knob to select the number of frames to record (1~1000)
	Interval	Turn the <b>M</b> knob to select the interval between recorded frames (1ms~1000s)
Refresh	ON	Refresh wave during recording
	OFF	Stop refreshing
Operate	Play	Begin to record
	Stop	Stop recording

**Note:**

Both of the waveforms of Channel 1 and Channel 2 will be recorded. If a Channel is turned off while recording, the waveform of the channel is invalid in the playback mode.

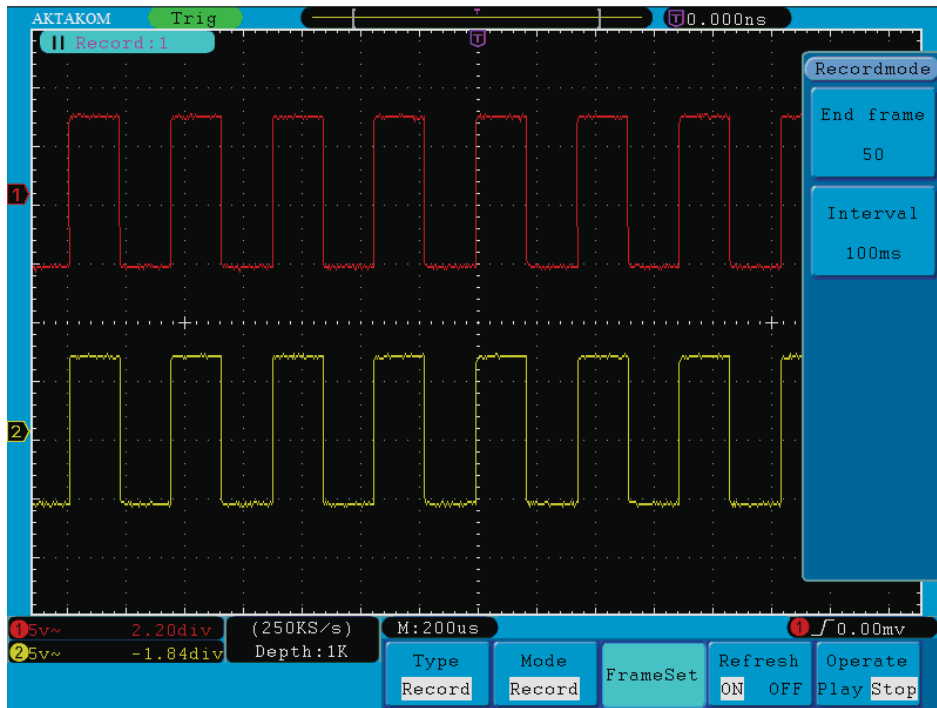

Fig.5-36 Wave Record

**Playback:** Play back the wave recorded or saved.

Playback menu shows as follows:

Menu	Setting	Instruction
Playback Mode Frame Set	Start frame	Turn the <b>M</b> knob to select the number of start frame to playback (1~1000)
	End frame	Turn the <b>M</b> knob to select the number of end frame to playback (1~1000)
	Cur frame	Turn the <b>M</b> knob to select the number of current frame to playback (1~1000)
	Interval	Turn the <b>M</b> knob to select the interval between played back frames (1ms~1000s)
Play mode	Loop	Play back the wave continuously
	Once	Play back the wave just one time
Operate	Play	Begin to record
	Stop	Stop recording

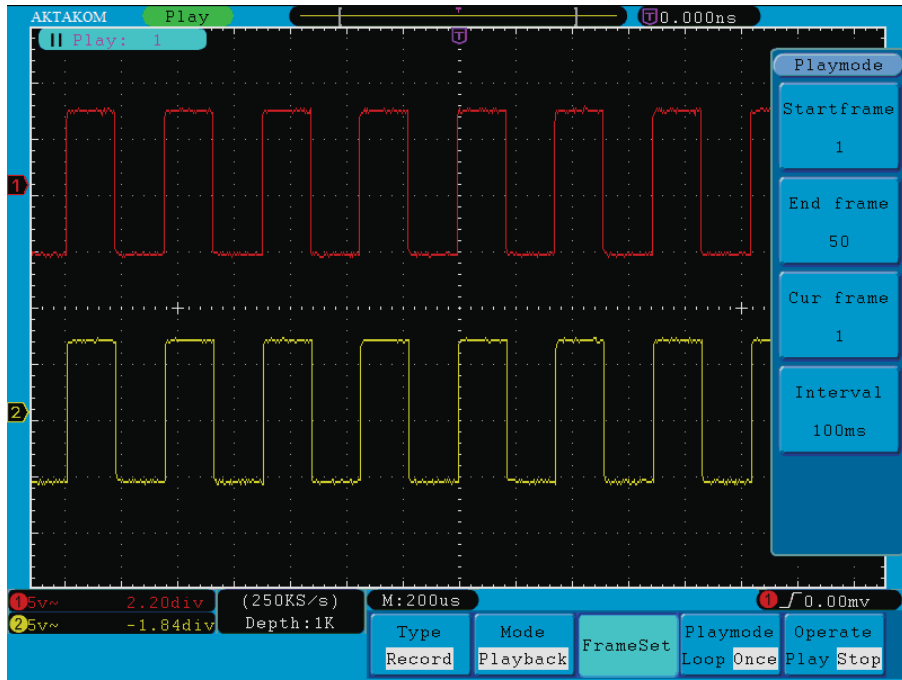
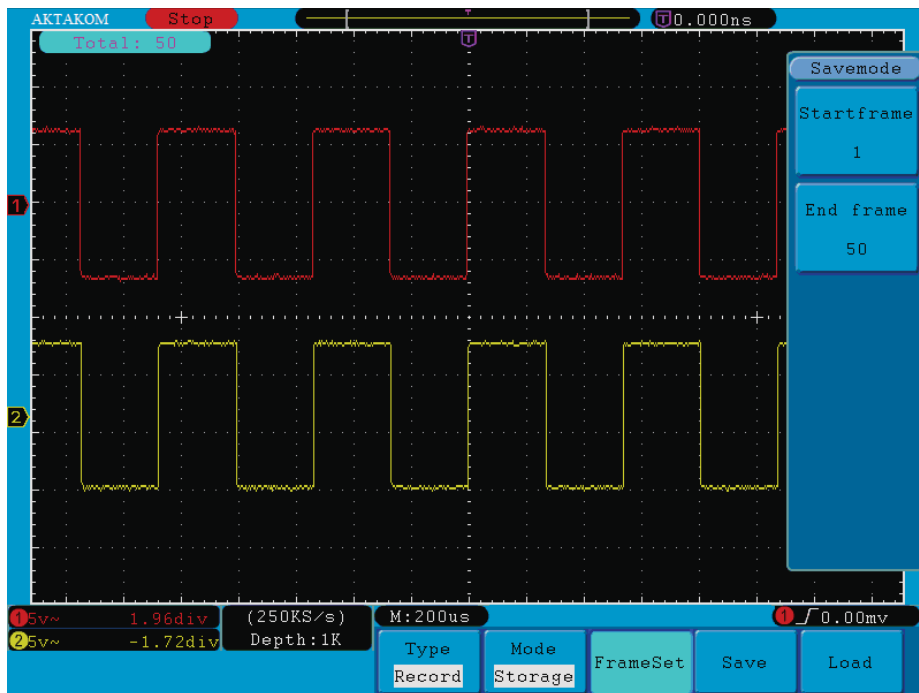

Fig. 5-37 Wave Playback

**Storage:** Save the current wave according to the start frame and end frame set.

Storage menu shows as follows:

Menu	Setting	Instruction
Storage Mode Frame Set	Start frame	Turn the <b>M</b> knob to select the number of start frame to store (1~1000)
	End frame	Turn the <b>M</b> knob to select the number of end frame to store (1~1000)
Save		Save the waveform record file to the internal memory
Load		Load the waveform record file from the memory



**Fig.5-38** Wave Storage

To use wave record function, do as follows:

- (1) Press **Save** button.
- (2) Press **H1** button, turn the **M** knob to choose **Record**.
- (3) Press **H2** button. In the Mode menu, press **F2** button to choose **Record**.
- (4) Press **H3** button. In the Frame Set menu, press **F1** button and turn the **M** knob to set End frame; press **F2** button and turn the **M** knob to select the interval between recorded frames.
- (5) Press **H4** button, choose whether to refresh the wave when recording.
- (6) Press **H5** button to start recording.
- (7) Press **H2** button. In the Mode menu, press **F3** button to enter the **Playback** mode. Set the frame range and **Play mode**. Then, press **H5** button to play.
- (8) To save the wave recorded, press **H2** button. In the Mode menu, press **F4** button to choose **Storage**, then set the range of frames to store, press **H4** button to save.
- (9) To load the waveform from the internal memory, press **Load**, and then enter playback mode to analyze the wave.

## How to Implement the Auxiliary System Function Setting

### ● Config

Press the **Utility** button and turn the **M** knob to select **Config** to go to the following menu.

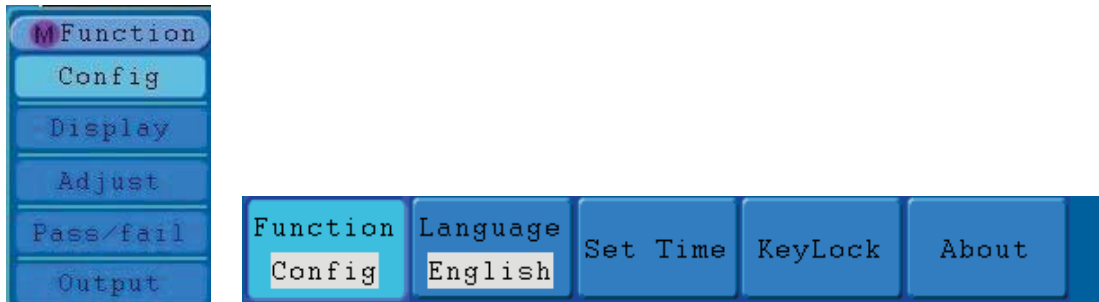

**Fig.5-39** Configuration Menu

The description of **Configuration Menu** is shown as the follows:

Function Menu	Setting	Description
language	Chinese English Others	Choose the display language of the operating system.
Set Time	Display    On Off	On/Off the date display
	Hour    Min	Setting Hour/Minute
	Day    Month	Setting Date/Month
	Year	Setting Year
KeyLock		Lock all keys. Unlock method: press <b>50%</b> button in trigger control area, then press <b>Force</b> button, repeat 3 times.
About		Version number and serial number showing

### ●Display

Press the **Utility** button and turn the **M** knob to select the **Display** to go to the following menu.



Fig.5-40 Display Menu

The description of **Display Menu** is shown as the follows:

Function Menu	Setting	Description
Backlight	0%~100%	Turn the <b>M</b> knob to adjust the backlight.
Graticule		Select the grid type
Battery	ON OFF	Turn on or off the battery display
Menu Time	5s~50s, OFF	Set the disappear time of menu

### ●Adjust

Press the **Utility** button and turn the **M** knob to select the **Adjust** to go to the following menu.

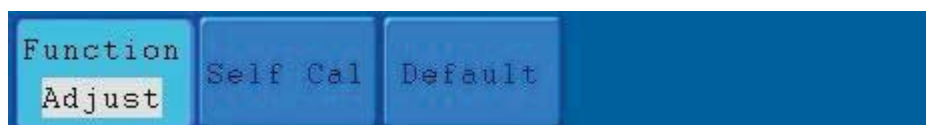

Fig.5-41 Adjust Menu

The description of **Adjust Menu** is shown as the follows:

Function Menu	Setting	Description
Self Cal		Carry out the self-calibration procedure.
Default		Call out the factory settings.

### Do Self Cal (Self-Calibration)

The self-calibration procedure can improve the accuracy of the oscilloscope under the ambient temperature to the greatest extent. If the change of the ambient temperature is up to or exceeds 5°C, the self-calibration procedure should be executed to obtain the highest level of accuracy.

Before executing the self-calibration procedure, disconnect the probe or wire and the input connector. Press the **Utility** button .Then, press the **H1** button and the function menu will display at the left of the screen, turn the **M** knob to choose “**Adjust**”, then press the **H2** button to choose “**Self Cal**”, entering the self-calibration procedure of the instrument.

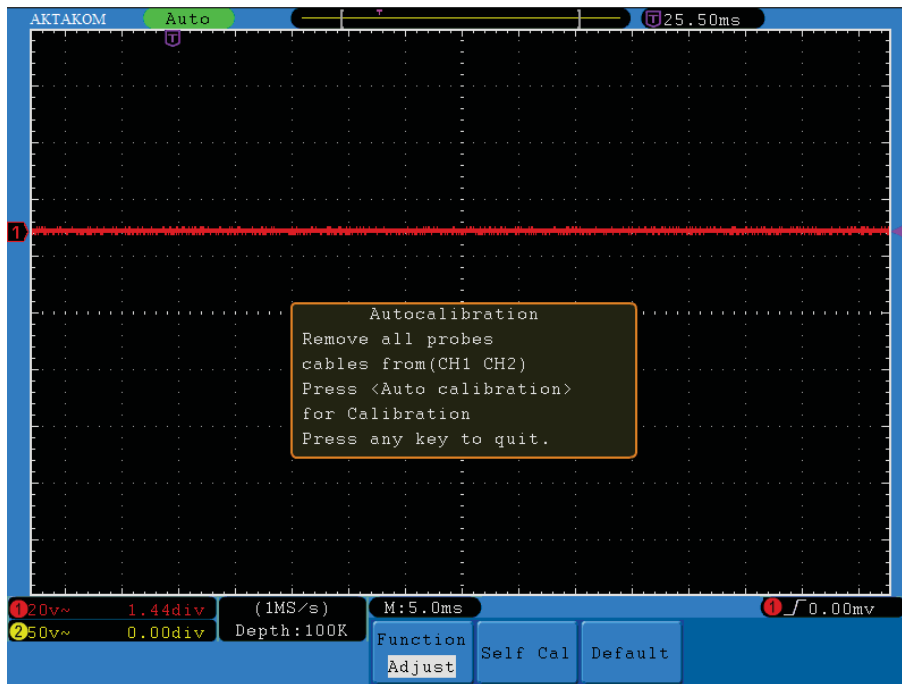

Fig.5-42 Self-Calibration

### ● Pass/Fail

The **Pass/Fail** function monitors changes of signals and output pass or fail signals by comparing the input signal that is within the pre-defined mask.

Press the **Utility** button and turn the **M** knob to select the **Pass/fail** to go to the following menu.

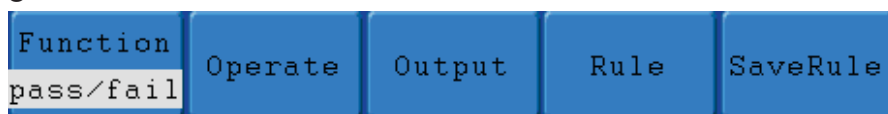

Fig.5-43 Pass/Fail menu

The description of **Pass/Fail Menu** is shown as the follows:

Function Menu	Setting	Description
operate	Enable	Control enable switch
	Operate	Control operate switch
Output	Pass	Signal tested corresponds with the rule
	Fail	Signal tested not correspond with the rule
	Beep	Beep when it satisfies the rule
	Stop	Stop once satisfying the rule
	Info	Control the display status of info frame
Rule	Source	Select source CH1, CH2 or Math
	Horizontal	Change the Horizontal tolerance value by turning the <b>M</b> knob
	Vertical	Change the Vertical tolerance value by turning the <b>M</b> knob
	Create	Use the rule set as testing rule
Save Rule	Number	Choose any one from Rule1~Rule8 as your rule name
	Save	Click Save to save the rule
	Load	Load some rule as the testing rule

**Pass/Fail test:**

Detect whether the input signal is within the limits of the rule, if it exceeds limits of the rule, it is “Fail”, otherwise it is “Pass”. Also it can output fail or pass signal by built-in, configurable and photoelectric isolation output port. To run the test, read the following steps:

1. Press **Utility** button, then **H1**, button turn the **M** knob to choose **Pass/fail** menu option, Pass/Fail menu will be displayed in the bottom.
2. **Enable switch on:** Press **H2** button to show **Operate** menu, then, press **F1** button to set **Enable** as **ON**.
3. **Create rule:** Press **H4** button to enter **Rule** setting menu. Press **F1** button to choose the source; Press **F2** button, turn the **M** knob to set Horizontal tolerance; Press **F3** button, turn the **M** knob to set Vertical tolerance; Press **F4** button to create the rule.
4. **Set output type:** Press **H3** button to enter **Output** option setting. Choose any one or two of the options “**Pass**”, “**Fail**” or “**Beep**”. “**Pass**” and “**Fail**” are mutually exclusive options, which could not be chosen simultaneously. “**Stop**” means stop once the condition satisfies your setting.
5. **Begin to test:** Press **H2** button, then **F2** button to select “**Start**”, the test will begin.
6. **Save rule:** Press **H5** button, then **F2** button to save the rules, which could be called up at once when need, press **F3** button to call up the rule saved.

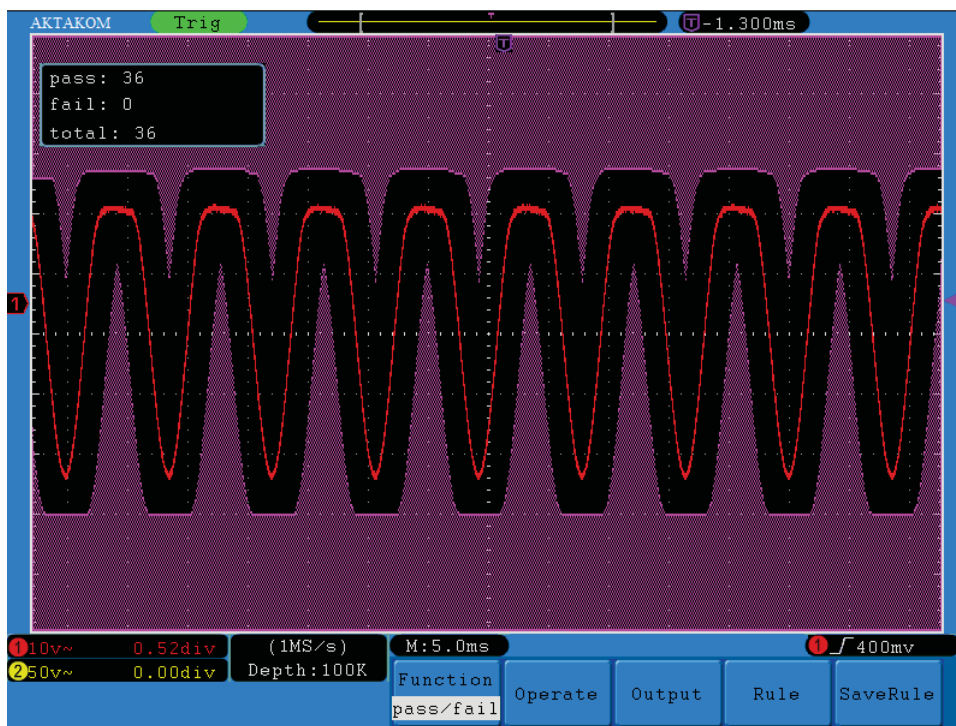

Fig.5-44 Pass/Fail test

**Note:**

1. When Pass/Fail is ON, if XY or FFT is ready to run, then Pass/Fail will be closed; under the mode of XY or FFT, Pass/Fail is unable.
2. Under the mode of Factory, Auto Scale and Auto Set, Pass/Fail will be closed.
3. When no save setting left in the rule save, tip will be given to show “NO RULE SAVED”.
4. Under the status of stop, data comparing will stop, and when it goes on running, the number of Pass/Fail will increase from the former number, not from zero.

● **Output**

Press the **Utility** button and turn the **M** to select the **Output** to go to the following menu.



Fig.5-45 Output menu

The description of **Output menu** is shown as the follows:

Function Menu	Setting	Description
Type	Trig level Pass/fail	Output trig signal synchronously Output High Level when Pass , and Low Level when Fail

**How to Measure Automatically**

Press the **Measure** button to display the menu for the settings of the Automatic



Measurements.

The oscilloscopes provide 20 parameters for auto measurement, including Vpp, Vmax, Vmin, Vtop, Vbase, Vamp, Vavg, Vrms, Overshoot, Preshoot, Freq, Period, Rise Time, Fall Time, Delay A→B, DelayA→B, +Width, -Width, +Duty, -Duty. That's 10 voltage and 10 time measurements in all.

The menu is displayed as **Fig.5-46**.

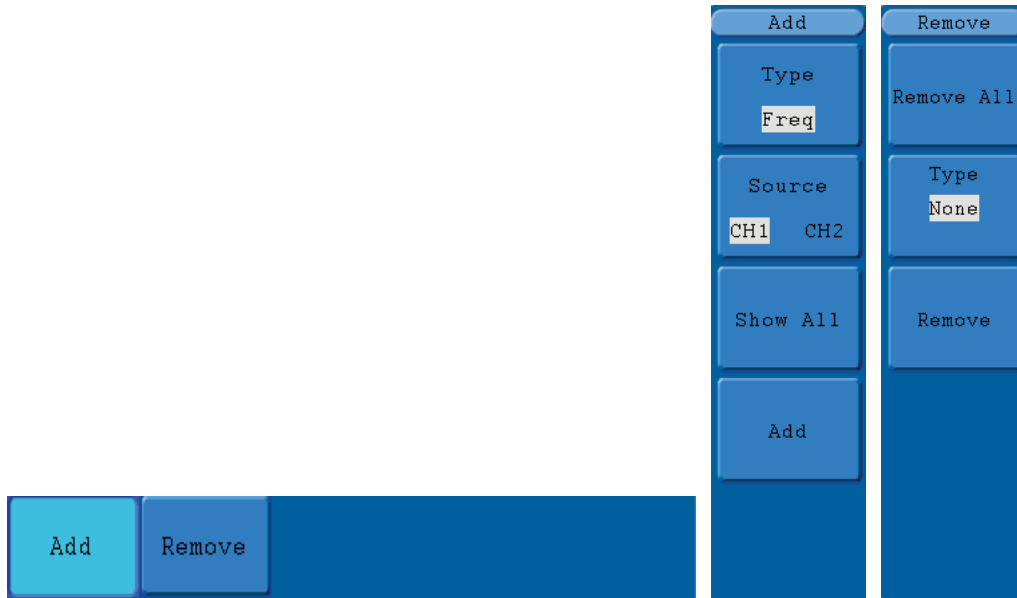

**Fig.5-46** Measure Menu

The “Automatic Measurements” menu is described as the following table:

Function Menu	Setting	Description	
Add	Type	Press F1 ,show the measure types	
	Source	CH1	Select the source
		CH2	
	Show all	Show all the measures on the screen	
Add	Add the selected measure types (showed at the left bottom, you could only add 8 types at most.)		
Remove	Remove all	Remove all the measures	
	Type	Turn <b>M</b> knob, select the types need to be deleted.	
	Remove	Remove the chosen measure type	

## Measure

The measured values can be detected on each channel simultaneously. Only if the waveform channel is in the ON state, the measurement can be performed. The automatic measurement cannot be performed in the following situation: 1) On the saved waveform. 2) On the mathematical waveform. 3) On the XY format. 4) On the Scan format.

Measure the frequency, the peak-to-peak voltage of the Channel CH1 and the mean, the RMS of the Channel CH2, following below steps:

1. Press the **Measure** button to show the automatic measurement function menu.
2. Press the **H1** button to display the **Add** menu.
3. Press the **F2** button and choose **CH1** as the source.
4. Press the **F1** button, the type items will display at the left of screen, and turn the **M** knob to choose **Period**.
5. Press the **F4** button, the period options added completes.
6. Press the **F1** button again, the type items will display at the left of screen, and turn the **M** to choose **Freq**.
7. Press the **F4** button, the frequency added completes, finish setting of CH1.
8. Press the **F2** button and choose **CH2** as the source.
9. Press the **F1** button, the type items will display at the left of screen, and turn the **M** to choose **Mean**.
10. Press the **F4** button, the Mean added completes.
11. Press the **F1** button, the type items will display at the left of screen, and turn the **M** to choose **PK-PK**.
12. Press the **F4** button, the PK-PK added completes, finish setting of CH2.

The measured value will be displayed in the reading window automatically (see Fig.5-47).

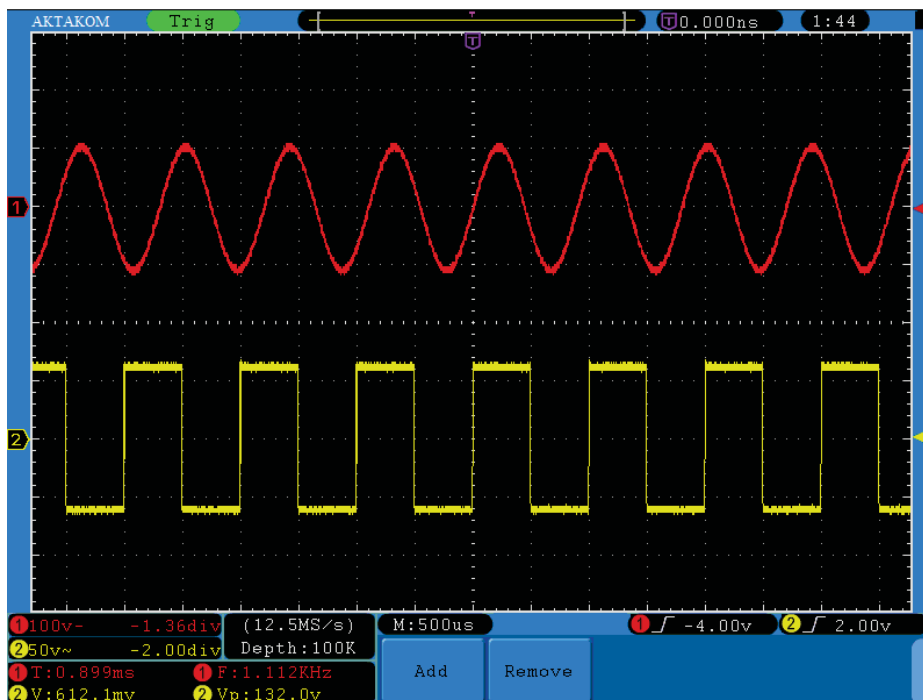

Fig.5-47 automatic measurement

## The automatic measurement of voltage parameters

The SDS series oscilloscopes provide automatic voltage measurements including  $V_{pp}$ ,  $V_{max}$ ,  $V_{min}$ ,  $V_{avg}$ ,  $V_{amp}$ ,  $V_{rms}$ ,  $V_{top}$ ,  $V_{base}$ , Overshoot and Preshoot. Fig.5-45 below shows a pulse with some of the voltage measurement points.

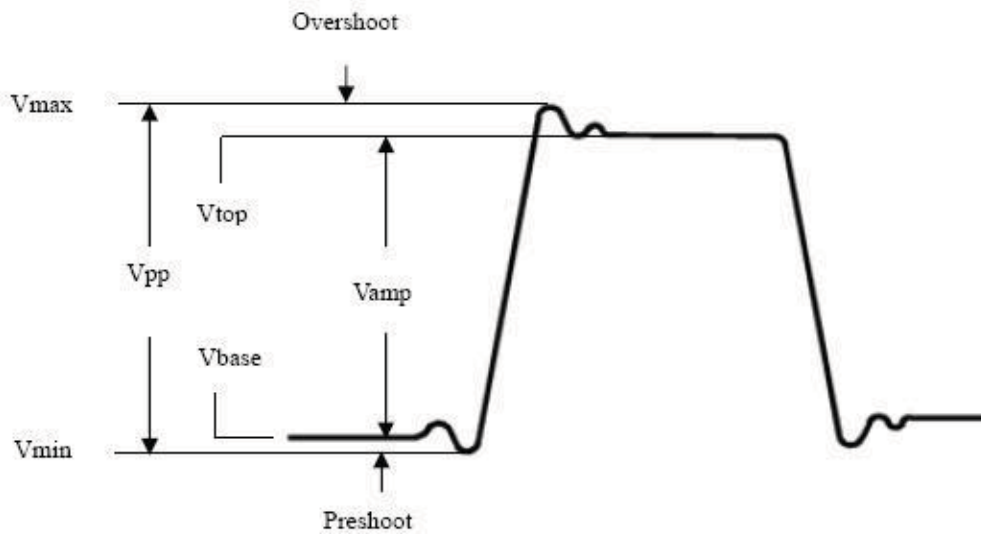

Fig.5-48

**$V_{pp}$ :** Peak-to-Peak Voltage.

**$V_{max}$ :** The maximum amplitude. The most positive peak voltage measured over the entire waveform.

**$V_{min}$ :** The minimum amplitude. The most negative peak voltage measured over the entire waveform.

**$V_{amp}$ :** Voltage between  $V_{top}$  and  $V_{base}$  of a waveform.

**$V_{top}$ :** Voltage of the waveform's flat top, useful for square/pulse waveforms.

**$V_{base}$ :** Voltage of the waveform's flat base, useful for square/pulse waveforms.

**Overshoot:** Defined as  $(V_{max}-V_{top})/V_{amp}$ , useful for square and pulse waveforms.

**Preshoot:** Defined as  $(V_{min}-V_{base})/V_{amp}$ , useful for square and pulse waveforms.

**Average:** The arithmetic mean over the entire waveform.

**$V_{rms}$ :** The true Root Mean Square voltage over the entire waveform.

### The automatic measurement of time parameters

The SDS series oscilloscopes provide time parameters auto-measurements include Frequency, Period, Rise Time, Fall Time, +Width, -Width, Delay 1→2, Delay 1→2, +Duty and -Duty.

Figure 5-46 shows a pulse with some of the time measurement points.

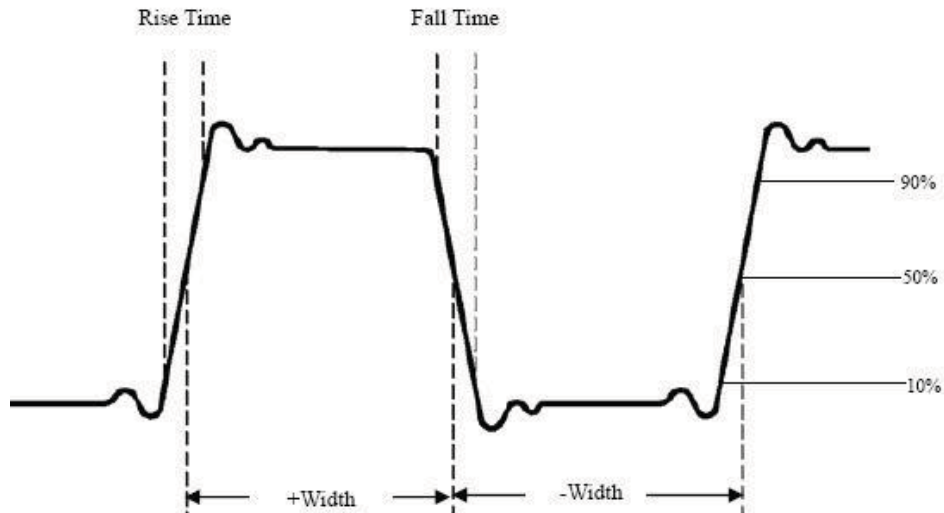

Fig.5-49

**Rise Time:** Time that the leading edge of the first pulse in the waveform takes to rise from 10% to 90% of its amplitude.

**Fall Time:** Time that the falling edge of the first pulse in the waveform takes to fall from 90% to 10% of its amplitude.

**+Width:** The width of the first positive pulse in 50% amplitude points.

**-Width:** The width of the first negative pulse in the 50% amplitude points.

**Delay 1→2 $\uparrow$ :** The delay between the two channels at the rising edge.

**Delay 1→2 $\downarrow$ :** The delay between the two channels at the falling edge.

**+Duty:** +Duty Cycle, defined as +Width/Period.

**-Duty:** -Duty Cycle, defined as -Width/Period.

## How to measure with cursors

Press the **Cursor** button to display the cursor measurement function menu (**CURS MEAS**) in the screen.

### The Cursor Measurement for normal model:

The cursor measurement includes **Voltage Measurement** and **Time Measurement** at normal model, shown as **Fig.5-50**.



Fig.5-50 CURS MEAS Menu

The description of the **cursor measurement menu** is shown as the following table:

Function Menu	Setting	Description
Type	OFF	Switch off the cursor measurement.
	Voltage	Display the voltage measurement cursor and menu.
Source	Time	Display the time measurement cursor and menu.
	CH1	Display the channel generating the waveform to which the cursor measurement will be applied.
CH2		

When carrying out the cursor measurement, the position of Cursor 1 can be adjusted with the **VERTICAL POSITION** knob of Channel 1, and that of Cursor 2 can be adjusted with the **VERTICAL POSITION** knob of Channel 2.

Perform the following operation steps for the voltage cursor measurement of the channel CH1:

1. Press **Cursor** and recall the Cursor Measure menu.
2. Press the **H2** button and choose **CH1** for **Source**.
3. Press the **H1** button, the **Type** menu will display at the right of the screen. Then press the **F2** button to choose **Voltage** for Type, with two purple dotted lines displayed along the horizontal direction of the screen, which indicating Cursor1 and Cursor2.
4. According to the measured waveform, adjust the positions of Cursor1 and Cursor2 by turning the **VERTICAL POSITION** knob of CH1 and CH2. Cursor increment window at the left bottom of waveform shows absolute value of D-value of cursor 1 and cursor 2 and the present position of the two cursors. (See **Fig.5-51**).

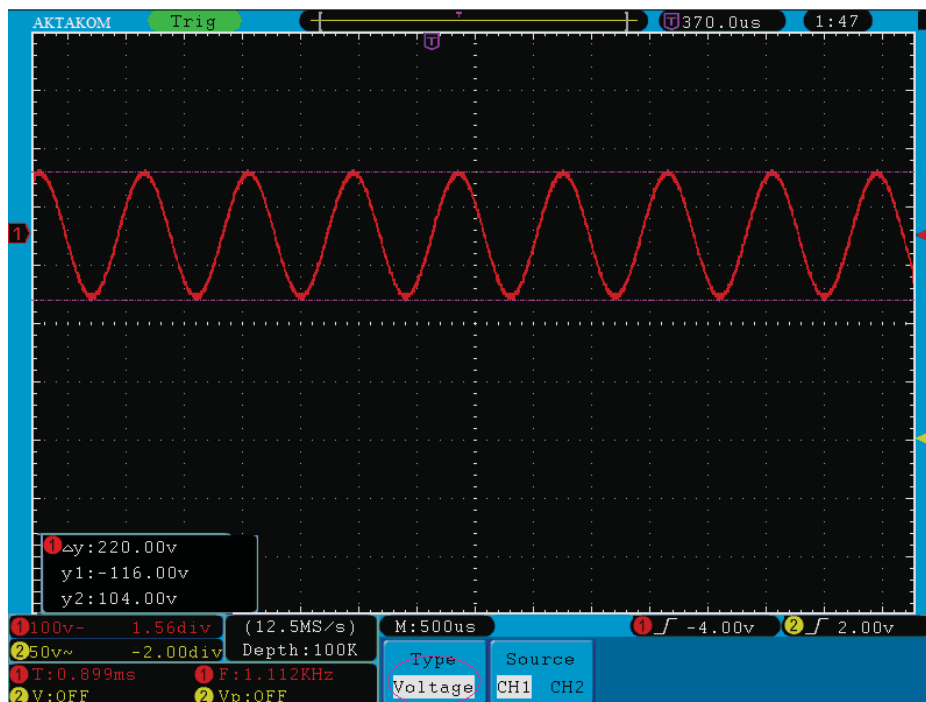

**Fig.5-51** Waveform of Voltage Cursor Measurement

Carry out the following operation steps for the time cursor measurement of the channel CH1:

1. Press **Cursor** and recall the Cursor Measure menu.
2. Press the **H2** button and choose **CH1** for **Source**.
3. Press the **H1** button, the **Type** menu will display at the right of the screen. Press the **F3** button to select **Time** for **Type**, with two purple dotted lines displayed along the vertical direction of the screen, which indicating Cursor 1 and Cursor 2.
4. According to the measured waveform, adjust the positions of Cursor1 and Cursor2 by turning the **VERTICAL POSITION** knob of CH1 and CH2. The cursor increment window at the left bottom of the waveform shows absolute difference, frequency and the present time of the two cursors.

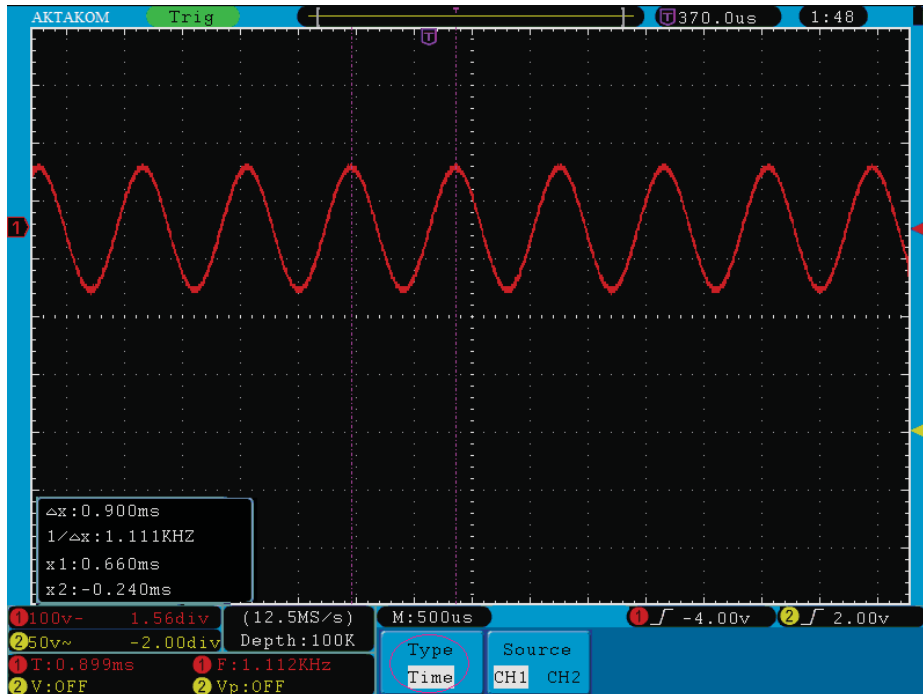

**Fig.5-52** Waveform of Cursor Measurement

### The Cursor Measurement for FFT model:

Press the **Cursor** button to display the cursor measurement function menu (CURS MEAS) in the screen, which includes **Vamp** Measurement and **Freq** Measurement at the mode of FFT, shown as **Fig.5-53**.



Fig.5-53 CURS MEAS Menu

The description of the cursor measurement menu is shown as the following table:

Function Menu	Setting	Description
Type	OFF	Switch off the cursor measurement.
	Vamp	Display the Vamp measurement cursor and menu.
	Freq	Display the Freq measurement cursor and menu.
Source	Math FFT	Display the channel for the cursor measure.

When carrying out the cursor measurement, the position of Cursor 1 can be adjusted with the **VERTICAL POSITION** knob of Channel 1, and that of Cursor 2 can be adjusted with the **VERTICAL POSITION** knob of Channel 2.

Perform the following operation steps for the Vamp cursor measurement:

1. Press **Cursor** and recall the Cursor Measure menu.
2. Press the **H1** button, the **Type** menu will display at the right of the screen. Press the **F2** button to select **Vamp** for **Type**, with two purple dotted lines displayed along the horizontal direction of the screen indicating Cursor1 and Cursor2.
3. According to the measured waveform, adjust the positions of Cursor1 and Cursor2 by turning the **VERTICAL POSITION** knob of CH1 and CH2. Cursor increment window at the left bottom shows absolute value of the two cursors amplitude difference and the present position.

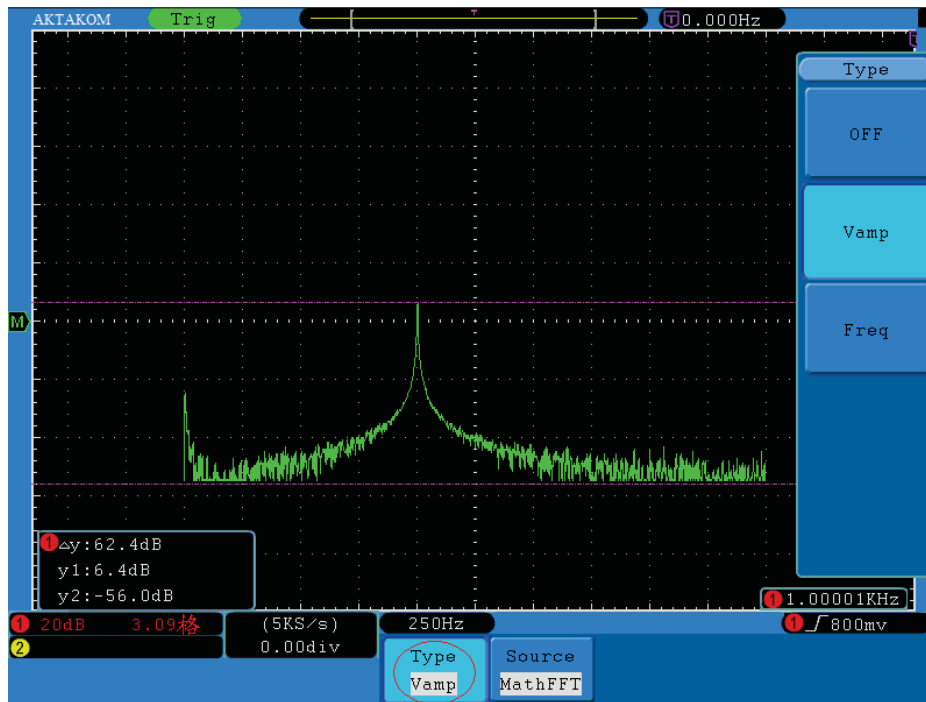

Fig.5-54 wave of Vamp cursor measurement

Carry out the following operation steps for the Freq cursor measurement:

1. Press **Cursor** and recall the Cursor Measure menu.
2. Press the **H1** button, the **Type** menu will display at the right of the screen. Press the **F3** button to select **Freq** for **Type**, with two purple dotted lines displayed along the vertical direction of the screen indicating the corresponding Cursor 1 and Cursor 2
3. According to the measured waveform, adjust the positions of Cursor1 and Cursor2 by turning the **VERTICAL POSITION** knob of CH1 and CH2. Increment window shows two cursors difference value and the present position. (See Fig.5-55).



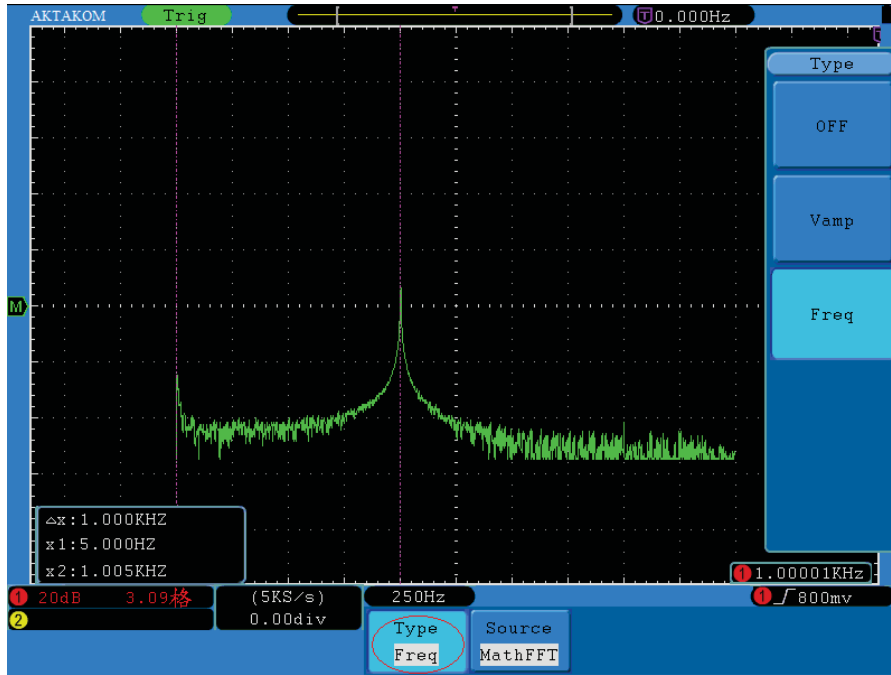

Fig.5-55 wave of Freq cursor measurement

## How to use Autoscale





The function is applied to follow-up signals automatically even if the signals change at any time. Autoscale enables the instrument to set up trigger mode, voltage division and time scale automatically according to the type, amplitude and frequency of the signals.





Fig.5-56 Autoscale menu

The menu is as follows:

Function Menu	Setting	Instruction
Autoscale	OFF	Turn off Autoscale.
	ON	Turn on Autoscale.

Mode		Follow-up and adjust the vertical and horizontal settings.
		Follow-up and adjust horizontal scale without changing vertical setting.
		Follow-up and adjust vertical scale without changing horizontal setting.
Wave		Show Multi-period waveforms.
		Only show one or two periods.

If you want to measure the two-channel signal, you can do as the follows:

1. Press **Autoscale** button, the function menu will appear.
2. Press **H1** to choose **ON**.
3. Press **H2** and choose  for **Mode** item.
4. Press **H3** and choose  for **Wave** item.

Then the wave is displayed in the screen, shown as **Fig.5-57**.

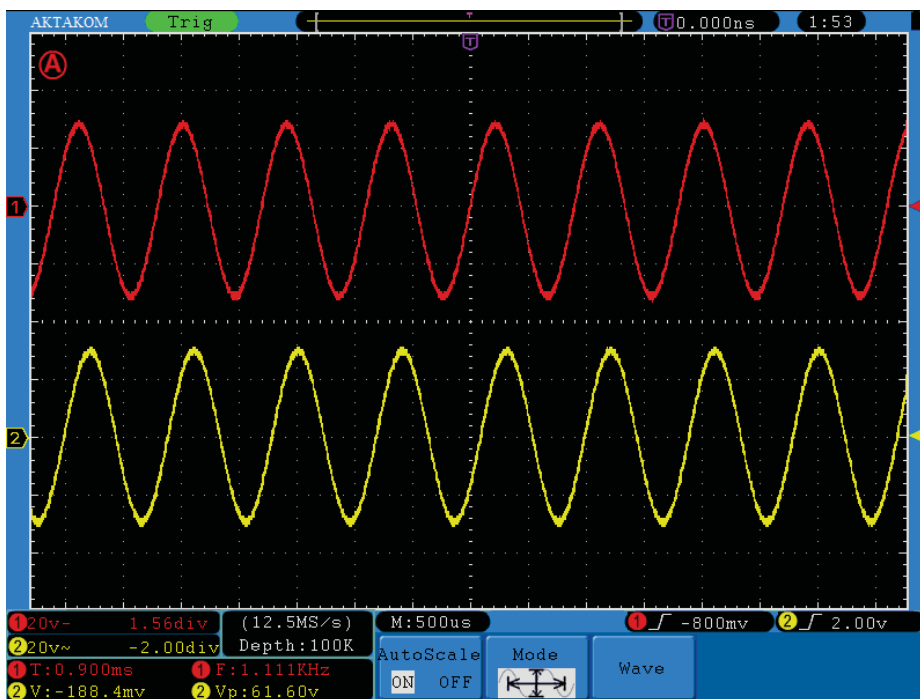

**Fig.5-57** Autoscale Horizontal- Vertical multi-period waveforms

**Note:**

1. Entering into Autoscale function and the (A) flicker will be at the top left of the screen. (flicker every 0.5 second)
2. In the mode of Autoscale, the oscilloscope can self-estimate “Trigger Type” (Single, and Alternate) and “mode” (Edge, Video). At this point, the trigger menu is not available.

3. At the mode of XY and STOP status, pressing **Autoset** to enter into Autoscale, DSO switches to YT mode and AUTO status.
4. At the mode of Autoscale, DSO is always in the state of DC coupling and AUTO triggering. In this case, making Triggering or Coupling settings have no effect.
5. At the mode of Autoscale, if adjust the vertical position, voltage division, trigger level or time scale of CH1 or CH2, the oscilloscope will turn off Autoscale function and if press **Autoset** again, the oscilloscope will enter into Autoscale.
6. Turn off the submenu at the Autoscale menu, the Autoscale is off and turn on the submenu still enters into the function.
7. When video triggering, the horizontal time scale is 50us. If one channel is showing edge signal, the other channel is showing video one, the time scale refers to 50us as video one as standard.
8. While the Autoscale is working, below settings will be made forcibly:
  - (1) The unit will switch from non-main time base to main time base status.
  - (2) The unit will switch to Peak detection menu while in the state of Average sampling mode.

## How to Use Executive Buttons

Executive Buttons include **Autoset**, **Run/Stop**, **Single**, **Copy**.

### Autoset

This button is used for the automatic setting of all control values of the instrument to generate the waveform suitable for observation. Press the **Autoset** button and the oscilloscope will perform the fast automatic measurement of the signal.

The function items of **Autoset** are shown as the following table:

Function Items	Setting
Acquisition Mode	Current
Vertical Coupling	DC
Vertical Scale	Adjust to the proper division.
Bandwidth	Full
Horizontal Level	Middle
Horizontal Sale	Adjust to the proper division
Trigger Type	Current
Trigger Source	Show the minimum number of channels.
Trigger Coupling	Current
Trigger Slope	Current
Trigger Level	Mid-point Setting
Trigger Mode	Auto
Display Format	YT

**Run/Stop:** Enable or disable the waveform sampling.

Notice: Under the **Stop** state, the vertical division and the horizontal time

---

base of the waveform can be adjusted within a certain range, in other words, the signal can be expanded in the horizontal or vertical direction.

When the horizontal time base equal to or is less than 50ms, the horizontal time base can be expanded for 4 divisions downwards.

**Single:** Press this button you can set the trigger mode as single directly, so when trigger occurs, acquire one waveform then stop.

**Copy:** This button is the shortcut of saving function of the Save function menu. Pressing this button is equal to the **Save** option in the Save function menu. The current waveform or the display screen could be saved according to the setting of the Save function menu. For more details, please see “Save Function Menu” on P49.

---

## 6. Demonstration

### Example 1: Measurement of Simple Signals

Observe an unknown signal in the circuit, and display and measure rapidly the frequency and peak-to-peak voltage of the signal.

**1. Carry out the following operation steps for the rapid display of this signal:**

- (1) Set the probe menu attenuation coefficient as **10X** and that of the switch in the probe switch as **10X** (see “How to Set the Probe Attenuation Coefficient” on P14).
- (2) Connect the probe of **Channel 1** to the measured point of the circuit.
- (3) Push down the **Autoset** button.

The oscilloscope will implement the **Autoset** to make the waveform optimized, based on which, you can further regulate the vertical and horizontal divisions till the waveform meets your requirement.

**2. Perform Automatic Measurement**

The oscilloscope can measure most of the displayed signals automatically. To measure the period and frequency of the Channel 1 and the mean and peak-to-peak voltage of the Channel 2, follow below steps:

- (1) Press the **Measure** button to show the automatic measurement function menu.
- (2) Press the **H1** to display the Add menu.
- (3) Press the **F2** button to choose **CH1** as the source.
- (4) Press the **F1** button, the type items will display at the left of screen, and turn the **M** knob to choose **Period**.
- (5) Press the **F4** button, the period measurement will be added.
- (6) Press the **F1** button again, the type items will display at the left of screen, and turn the **M** knob to choose **Freq**.
- (7) Press the **F4** button, the frequency measurement will be added, finish settings of channel 1.
- (8) Press the **F2** button to choose **CH2** as the source.
- (9) Press the **F1** button, the type items will display at the left of screen, and turn the **M** knob to choose **Mean**.
- (10) Press the **F4** button, the mean measurement will be added.
- (11) Press the **F1** button, the type items will display at the left of screen, and turn the **M** knob to choose **PK-PK**.

(12) Press the **F4** button, the peak-to-peak voltage measurement will be added, finish settings of channel 2.

Then, the period, frequency, mean and peak-to-peak voltage will be displayed at the bottom left of the screen and change periodically (see **Fig.6-1**).

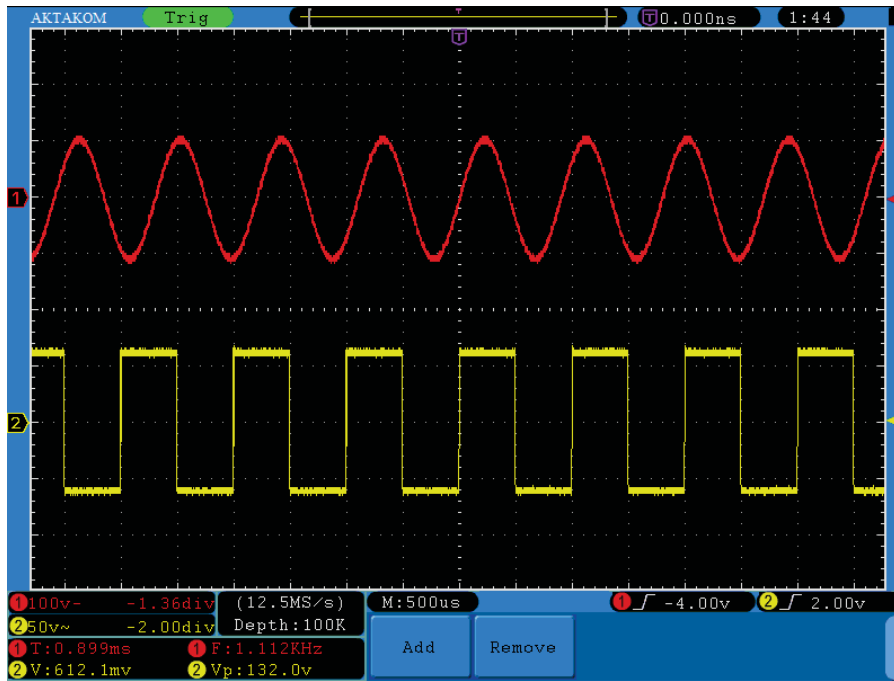

**Fig.6-1** Waveform of Automation Measurement

## Example 2:

### Gain of the Amplifier in the Metering Circuit

Set the probe menu attenuation coefficient as **10X** and that of the switch in the probe as **10X** (see “How to Set the Probe Attenuation Coefficient” on P14).

Connect the oscilloscope CH1 channel with the circuit signal input end and the CH2 channel to the output end.

#### Operation Steps:

- (1) Push down the **Autoset** button and the oscilloscope will automatically adjust the waveforms of the two channels into the proper display state.
- (2) Push down the **Measure** button to show the Measure menu.
- (3) Press the **H1** button.
- (4) Press the **F2** button and choose **CH1**.
- (5) Press the **F1** button and turn the **M** knob to choose **PK-PK**.
- (6) Press the **F2** button and choose **CH2**.

- (7) Press the **F1** button again and turn the **M** knob to choose **PK-PK**.
- (8) Read the peak-to-peak voltages of Channel 1 and Channel 2 from the bottom left of the screen (See **Fig.6-2**).
- (9) Calculate the amplifier gain with the following formulas.

Gain = Output Signal / Input signal

Gain (db) = 20×log (gain)

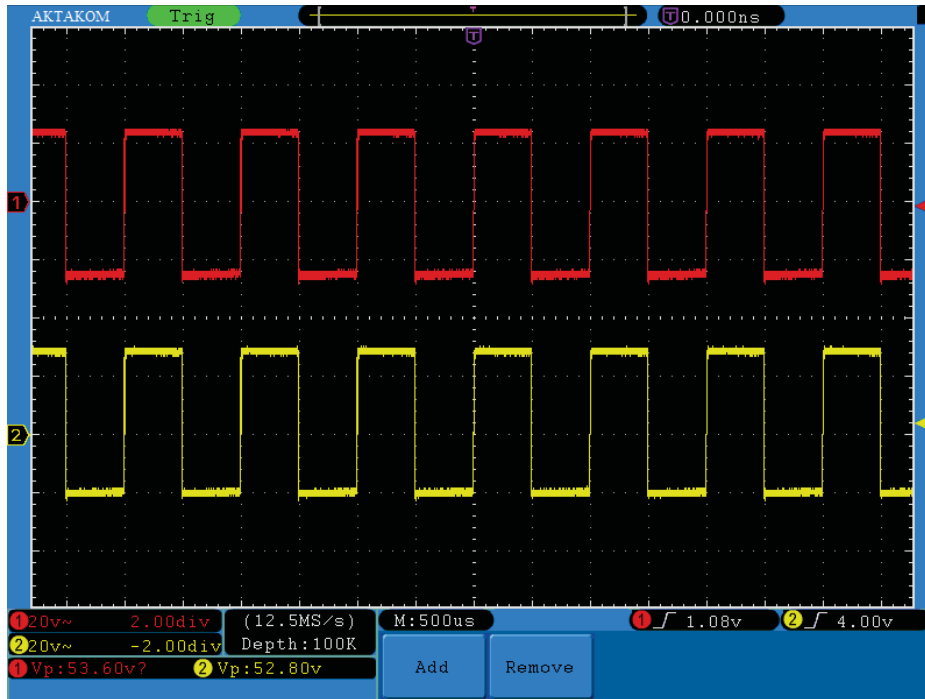

**Fig.6-2** Waveform of Gain Measurement

### Example 3: Capture the Single Signal

The digital storage oscilloscope takes the lead in providing the convenience capturing of such non-periodic signals as pulse and burr, etc. If you intent to capture a single signal, you cannot set the trigger level and the trigger edge unless you have particular prior knowledge of this signal. For example, if the pulse is the logic signal of a TTL level, the trigger level should be set to 2 volts and the trigger edge be set as the rising edge trigger. If it is uncertain as to the signal, you can make an observation of it in advance under the automatic or ordinary mode to determine the trigger level and the trigger edge.

**The operation steps are as follows:**

- (1) Set the probe menu attenuation coefficient to 10X and that of the switch in the probe to 10X (see “How to Set the Probe Attenuation Coefficient” on P14).
- (2) Adjust the **VOLTS/DIV** and **SEC/DIV** knobs to set up a proper vertical and horizontal ranges for the signal to be observed.

- 
- (3) Press the **Acquire** button to display the Acquire menu.
  - (4) Press the **H1** button to display the Acquire Mode menu.
  
  - (5) Press the **F2** button to choose **Peak detect**.
  - (6) Press the **Trigger Menu** button to display the Trigger menu.
  - (7) Press the **H1** button to display the Trigger Type menu.
  - (8) Press the **F1** to choose **Single** as the type.
  - (9) Turn the **M** knob to choose **Edge** as the mode.
  - (10) Press the **H2** button to display the **Source** menu.
  - (11) Press the **F1** button to choose **CH1** as the source.
  - (12) Press the **H3** button to display the Coupling menu; press the F2 button to choose **DC** as the Coupling.
  - (13) Press the **H4** button to choose  (rising) as the Slope.
  - (14) Rotate the **TRIG LEVEL** knob and adjust the trigger level to the mid-value of the signal to be measured.
  - (15) If the **Trigger State Indicator** at the top of the screen does not indicate **Ready**, push down the **Run/Stop** button and start acquiring, waiting the emergence of the signal in conformity with the trigger conditions. If a signal reaches to the set trigger level, one sampling will be made and then displayed in the screen. With this function, any random occurrence can be captured easily. Taking the burst burr of larger amplitude for example, set the trigger level to the value just greater than the normal signal level, and then presses the **Run/Stop** button and waits. When there is a burr occurring, the instrument will trigger automatically and record the waveform generated during the period around the trigger time. With the **HORIZONTAL POSITION** knob in the horizontal control area in the panel rotated, you can change the horizontal position of the trigger position to obtain the negative delay, making an easy observation of the waveform before the burr occurs (see **Fig.6-3**).



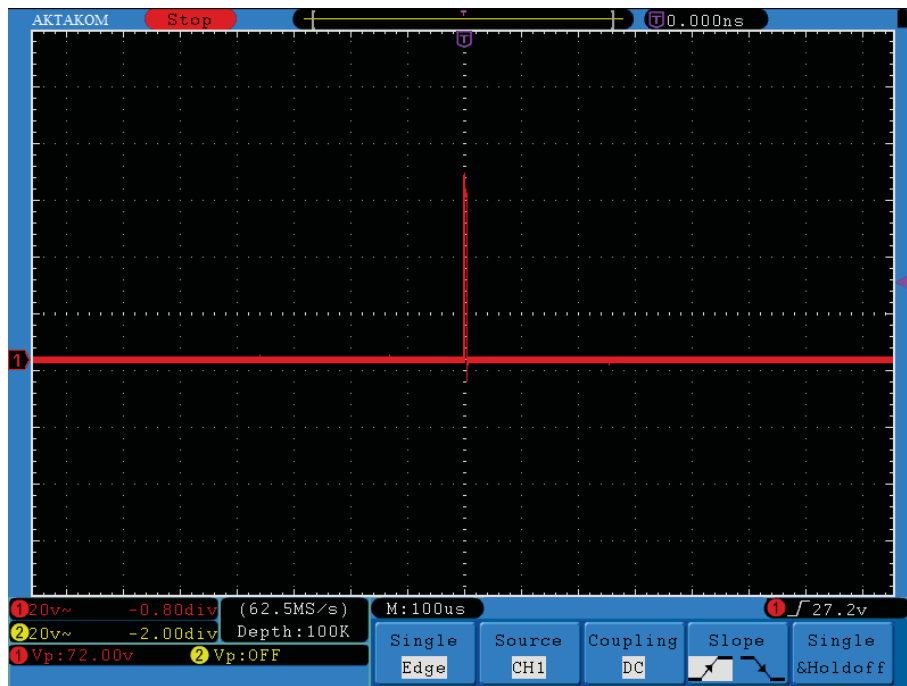

Fig.6-3 Capture the Single Signal

## Example 4: Analyze the Details of a Signal

### Observe the Signal Containing Noises

If the signal is interfered by the noise, the noise may cause a failure in the circuit. For the analyzing of the noise in detail, please operate the instrument according to the following steps:

- (1) Press the **Acquire** button to display the Acquire menu.
- (2) Press the **H1** button to display **ACQU Mode** menu.
- (3) Press the **F2** button to choose **Peak detect**.

In this case, the screen display contains the waveform of a random noise. Especially when the time base is set as Low Speed, then noise peak and burr contained in the signal can be observed with the peak detection (See **Fig.6-4**).

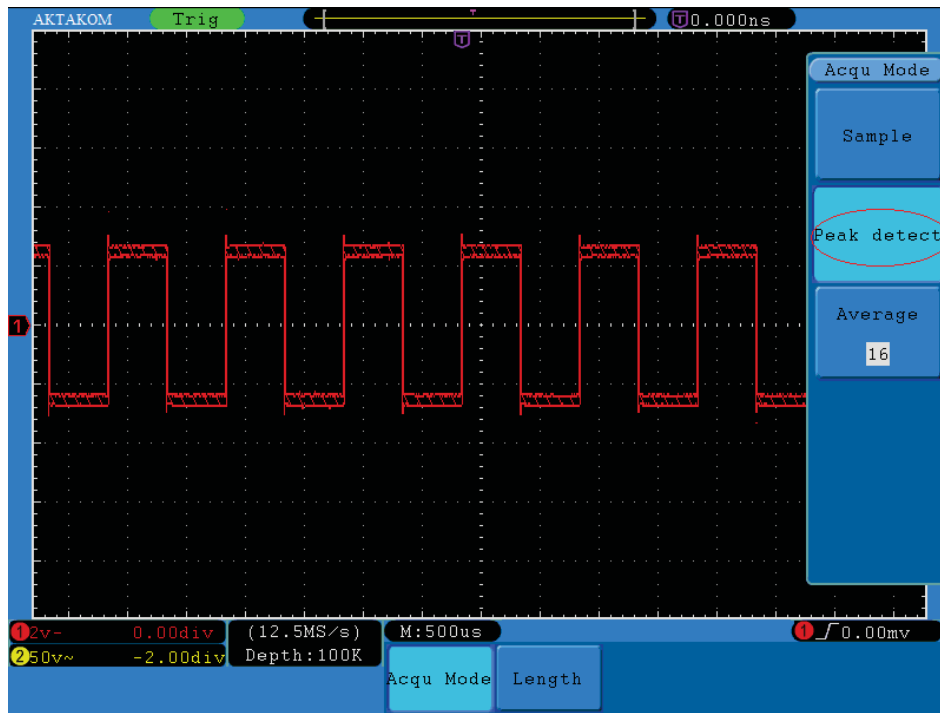

**Fig.6-4** Waveform of the Signal Containing Noises

### Separate Noises from the Signal

When analyze the waveform of a signal, you should remove the noise in it. For the reduction of the random noise in the oscilloscope display, please operate the instrument according to the following steps:

- (1) Press the **Acquire** button to display the Acquire menu.
- (2) Press the **H1** button to display **ACQU Mode** menu.
- (3) Press the **F3** button, turn the **M** knob and observe the waveform obtained from averaging the waveforms of different average number.

After the averaging, the random noise is reduced and the detail of the signal is easier to be observed. Shown as follows, after the noise is removed, the burrs on the rising and falling edges appear (see **Fig.6-5**).

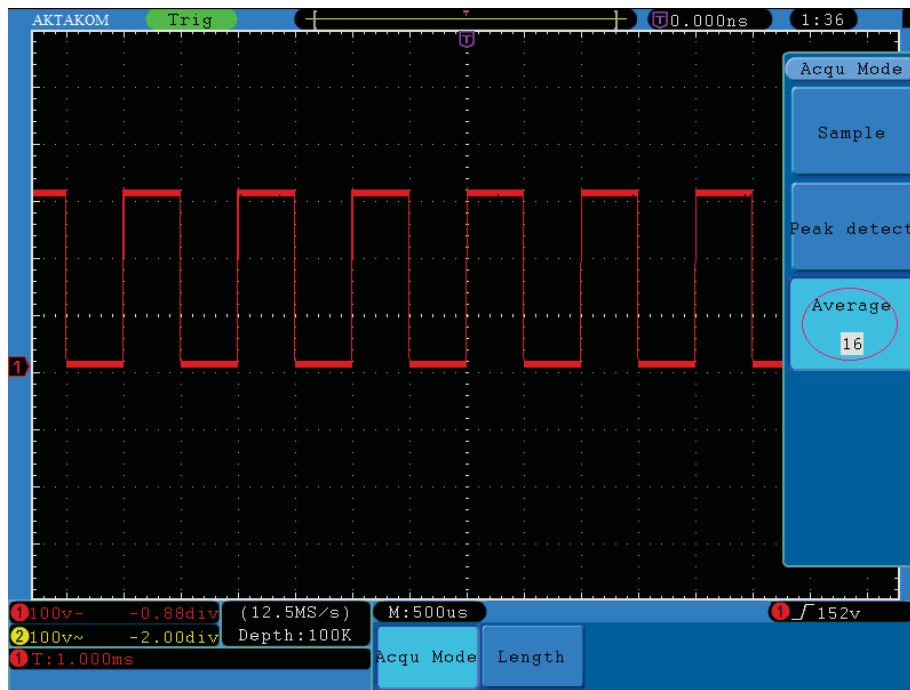

Fig.6-5 Waveform of the Noise-Removed Signal

## Example 5: Application of X-Y Function

### Examine the Phase Difference between Signals of two Channels

Example: Test the phase change of the signal after it passes through a circuit network.

Connect the oscilloscope with the circuit and monitor the input and output signals of the circuit.

For the examination of the input and output of the circuit in the form of X-Y coordinate graph, please operate according to the following steps:

- (1) Set the probe menu attenuation coefficient for **10X** and that of the switch in the probe for **10X** (see “How to Set the Probe Attenuation Coefficient” on P14).
- (2) Connect the probe of channel 1 to the input of the network and that of Channel 2 to the output of the network.
- (3) Push down the **Autoset** button, with the oscilloscope turning on the signals of the two channels and displaying them in the screen.
- (4) Turn the **VOLTS/DIV** knob, making the amplitudes of two signals equal in the rough.
- (5) Press the **Display** button and recall the Display menu.
- (6) Press the **H3** button and choose **XY Mode** as **ON**.  
The oscilloscope will display the input and terminal characteristics of the network in the Lissajous graph form.
- (7) Turn the **VOLTS/DIV** and **VERTICAL POSITION** knobs, optimizing the

waveform.

- (8) With the elliptical oscillogram method adopted, observe and calculate the phase difference (see Fig.6-6).

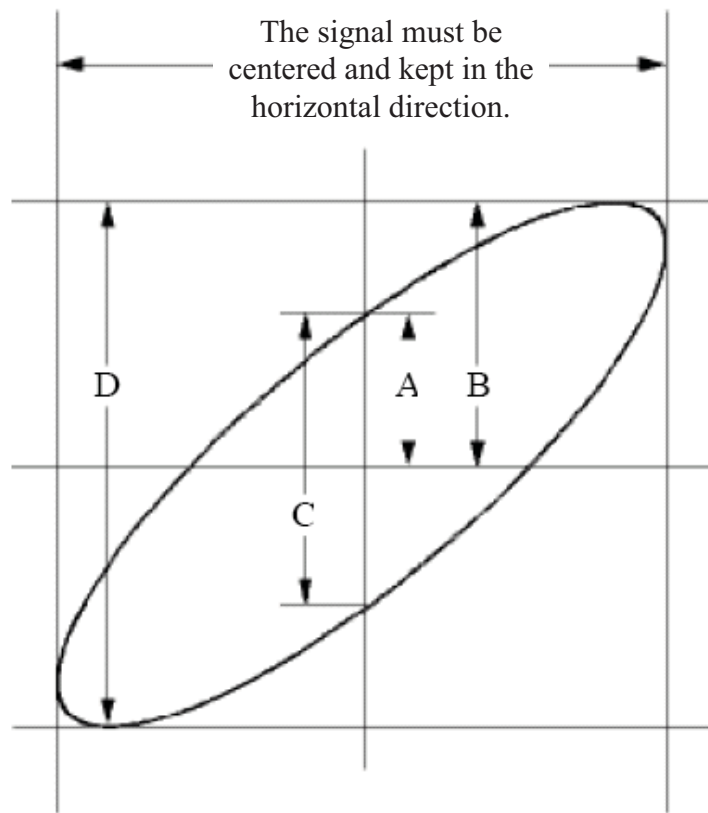

**Fig.6-6** Lissajous Graph

Based on the expression  $\sin q = A/B$  or  $C/D$ , there into,  $q$  is the phase difference angle, and the definitions of A, B, C, and D are shown as the graph above. As a result, the phase difference angle can be obtained, namely,  $q = \pm \arcsin (A/B)$  or  $\pm \arcsin (C/D)$ . If the principal axis of the ellipse is in the I and III quadrants, the determined phase difference angel should be in the I and IV quadrants, that is, in the range of  $(0 \sim \pi / 2)$  or  $(3\pi / 2 \sim 2\pi)$ . If the principal axis of the ellipse is in the II and IV quadrants, the determined phase difference angle is in the II and III quadrants, that is, within the range of  $(\pi / 2 \sim \pi)$  or  $(\pi \sim 3\pi / 2)$ .

## Example 6: Video Signal Trigger

Observe the video circuit of a television, apply the video trigger and obtain the stable video output signal display.

### Video Field Trigger

For the trigger in the video field, carry out operations according to the following steps:

- (1) Press the **Trigger Menu** button to display the trigger menu.

- (2) Press the **H1** button to display the trigger type menu.
- (3) Press the **F1** button to choose **Single** for Type.
- (4) Turn the **M** knob to choose **Video** as the mode.
- (5) Press the **H2** button to display the Source menu.
- (6) Press the **F1** button to choose **CH1** for Source.
- (7) Press the **H3** button to display the Module menu.
- (8) Press the **F1** button to choose **NTSC** for the modulation.
- (9) Press the **H4** button to display the sync menu.
- (10) Press the **F2** button to choose **Field** for Sync.
- (11) Turn the **VOLTS/DIV**, **VERTICAL POSITION** and **SEC/DIV** knobs to obtain a proper waveform display (see **Fig.6-7**).

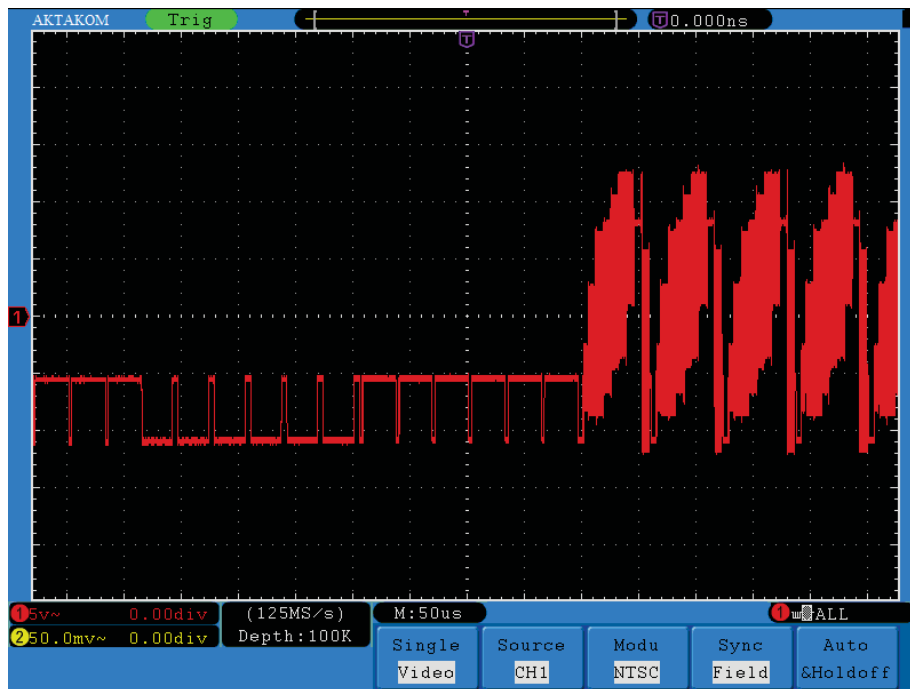

**Fig.6-7** Waveform Obtained from Video Field Trigger

---

## 7. F.A.Q

### 1. In the case of that the oscilloscope is still in the black-screen state without any display after the power is switch on, implement the following fault treatment procedure.

- Check whether the power connection is connected properly.
- Check whether the power switch is pushed down to the designated position.
- Check whether the fuse which is beside the AC power input jack is blew (the cover can be pried open with a screwdriver).
- Restart the instrument after completing the checks above.
- If this product still cannot work normally, please get in touch with AKTAKOM and we will be under your service.

### 2. After acquiring the signal, carry out the following operations if the waveform of the signal is not displayed in the screen.

- Check whether the probe is properly connected to the signal connecting wire.
- Check whether the signal connecting wire is correctly connected to the BNC (namely, the channel connector).
- Check whether the probe is properly connected with the object to be measured.
- Check whether there is any signal generated from the object to be measured (the trouble can be shot by the connection of the channel from which there is a signal generated with the channel in fault).
- Make the signal acquisition operation again.

### 3. The measured voltage amplitude value is 10 times greater or smaller than the actual value.

Check whether the channel attenuation coefficient and the attenuation ration of the probe used in practical application is match (see “How to Set the Probe Attenuation Coefficient” on P14).

### 4. There is waveform displayed, but it is not stable.

- Check whether the **Source** item in the **TRIG MODE** menu is in conformity with the signal channel used in the practical application.
- Check on the trigger **Type** item: The common signal chooses the **Edge** trigger mode for **Type** and the video signal the **Video**. If Alternate trigger is selected, both of the channel 1 and channel 2 trigger levels should be adjusted to the proper position. Only if a proper trigger mode is applied, the waveform can be displayed steadily.
- Try to change the trigger coupling into the high frequency suppress and the low frequency suppress to smooth the high frequency or low frequency noise triggered by the interference.

### 5. No Display Responses to the Push-down of Run/Stop.

Check whether Normal or Signal is chosen for Polarity in the TRIG MODE menu and the trigger level exceeds the waveform range.

If it is, make the trigger level is centered in the screen or set the trigger mode as Auto.

In addition, with the **Autoset** button pressed, the setting above can be completed automatically.

- 
- 6. After the Average value sampling is set in the Acqu Mode (see “How to Implement Sampling Setup” on P42 ), or the longer duration is set in the Persist in Display (see “Persist” on P46), the display rate is slowed down.**

It is a normal phenomenon.

## 8. Technical Specifications

Unless otherwise specified, the technical specifications applied are applicable to the probe with the attenuation switch setting 10X and the SDS series digital oscilloscope. Only if the oscilloscope fulfill the following two conditions at first, can these specification standards be reached.

- This instrument should run for more than 30 minutes continuously under the specified operating temperature.
- If the change range of the operating temperature is up to or exceeds 5°C, open the system function menu and execute the “Auto-calibration” procedure (see “How to Implement Auto-calibration” on P16).

All specification standards can be fulfilled, except one(s) marked with the word “Typical”.

Performance Characteristics		Instruction	
Bandwidth		ADS2061	60MHz
Channel		2 + 1 (External)	
Acquisition	Mode	Normal, Peak detect, Averaging	
	Sample rate (real time)	ADS2061	500MS/s (250MS/s for dual channels)
Input	Input coupling	DC, AC, Ground	
	Input impedance	1MΩ±2%, in parallel with 10pF±5pF	
	Probe attenuation factor	1X, 10X, 100X, 1000X	
	Max. input voltage	400V (PK-PK) (DC + AC PK-PK)	
	Bandwidth limit	20MHz, full bandwidth	
	Channel isolation	50Hz: 100 : 1 10MHz: 40 : 1	
	Time delay between channel(typical)	150ps	
Horizontal System	Sampling rate range	ADS2061	0.5S/s~500MS/s single channel* 0.5S/s~250MS/s dual channel



Performance Characteristics		Instruction		
	Interpolation	(sin x) /x		
	Record length	10M points on each channel		
	Scanning speed (S/div)	ADS2061	5ns/div~100s/div, step by 1~2~5	
	Sampling rate / relay time accuracy	±100ppm		
	Interval (ΔT) accuracy (DC~100MHz)	Single: ±(1 interval time+100ppm×reading+0.6ns); Average>16: ±(1 interval time +100ppm×reading+0.4ns)		
	Vertical system	A/D converter	8 bits resolution (2 Channels simultaneously)	
Sensitivity		2mV/div~10V/div		
Displacement		±1V(2mV ~ 50mV), ±10V(100mV ~ 1V), ±100V(2V~10V)		
Analog bandwidth		60MHz, 100MHz, 200MHz, 300MHz		
Single bandwidth		Full bandwidth		
Low Frequency		≥5Hz (at input, AC coupling, -3dB)		
Rise time		60MHz	≤5.8ns (at input, Typical)	
		100MHz	≤3.5ns (at input, Typical)	
		200MHz	≤1.75ns (at input, Typical)	
		300MHz	≤1.17ns (at input, Typical)	
DC accuracy		±3%		
DC accuracy (average)	Average > 16: ±(3% rdg + 0.05 div) for ΔV			
Measurement	Cursor	ΔV and ΔT between cursors		

Performance Characteristics		Instruction	
	Automatic	Vpp, Vmax, Vmin, Vtop, Vbase, Vamp, Vavg, Vrms, Overshoot, Preshoot, Freq, Period, Rise Time, Fall Time, DelayA→B $\overline{\uparrow}$ , DelayA→B $\overline{\downarrow}$ , +Width, -Width, +Duty, -Duty	
	Waveform Math	+, -, *, / ,FFT	
	Waveform storage	15 waveforms	
	Lissajous figure	Bandwidth	Full bandwidth
		Phase difference	±3 degrees
Frequency ( typical)	1KHz square wave		
<b>Communication port</b>	USB2.0, USB for file storage, VGA port or RS-232		

\* Single channel is when only one input channel is working.

#### Trigger:

Performance Characteristics		Instruction
Trigger level range	Internal	±6 div from the screen center
	EXT	±600mV
	EXT/5	±3V
Trigger level Accuracy (typical)	Internal	±0.3div
	EXT	±(40mV + 6% of Set Value)
	EXT/5	±(200mV +6% of Set Value)
Trigger displacement	According to Record length and time base	
Trigger Holdoff range	100ns~10s	
50% level setting(typical)	Input signal frequency ≥50Hz	
Edge trigger	slope	Rising、Falling
	Sensitivity	0.3div

Performance Characteristics		Instruction
Pulse trigger	Trigger condition	Positive pulse: >、<、= negative pulse: >、<、=
	Pulse Width range	24ns~10s
Video Trigger	Modulation	Support standard NTSC、PAL and SECAM broadcast systems
	Line number range	1-525 (NTSC) and 1-625 (PAL/SECAM)
Slope Trigger	Trigger condition	Positive pulse: >、<、= negative pulse: >、<、=
	Time setting	24ns~10s
Alternate Trigger	Trigger on CH1	Edge, Pulse, Video, Slope
	Trigger on CH2	Edge, Pulse, Video, Slope

---

## General Technical Specifications

### Display

Display Type	8" Colored LCD (Liquid Crystal Display)
Display Resolution	800 (Horizontal) × 600 (Vertical) Pixels
Display Colors	65536 colors, TFT screen

### Output of the Probe Compensator

Output Voltage (Typical )	About 5V, with the Peak-to-Peak voltage equal to or greater than 1MΩ of load.
Frequency (Typical )	Square wave of 1KHz

### Power

Mains Voltage	100~240 VAC RMS, 50/60Hz, CAT II
Power Consumption	< 18W
Fuse	1A, T grade, 250V
Battery (optional)	Cell:558792 4000mAh/3.7V Pack:2s2p 7.4V/8000mAh

### Environment

Temperature	Working temperature: 0 °C~ 40 °C Storage temperature: -20 °C~ +60 °C
Relative Humidity	≤ 90%
Height	Operating: 3,000 m Non-operating: 15,000 m
Cooling Method	Natural convection

### Mechanical Specifications

Dimension	340mm× 155mm×70mm (L*H*W)
Weight	About 1.82 kilogram

### Interval Period of Adjustment:

One year is recommended for the calibration interval period.

---

## 9. Appendix

### Appendix A: Enclosure

#### Standard Accessories:

- 2 Passive probe: 1.2 m, 1:1 (10:1)
- CD: x 1 (PC link application software)
- Power cord: 1pcs, up to the standards of the country in which it is used.
- USB cable
- User Manual: 1pcs

#### Options:

- Battery

### Appendix B: Maintenance, Cleaning and Repairing

#### General Maintenance

Please don't store or put the instrument in the place where the liquid crystal display will be directly exposed to the sunlight for a long time.

**Caution:** The instrument or probe should not be stained with the spraying agent, liquid and solvent to avoid any damage to it.

#### Cleaning

Check the probe and instrument regularly according to their operating state. Clean the external surface of the instrument following the steps shown below:

1. Please wipe the dust from the instrument and probe surface with a soft cloth. Do not make any scuffing on the transparent LCD protection screen when clean the LCD screen.
2. Clean the instrument with a wet soft cloth not dripping water, during the period of which please pay attention to the disconnection of power. It is recommended to scrub with soft detergent or fresh water. Please don't apply any corrosive chemical cleaning agent to prevent the instrument or probe from damage.



**Warning:** Before power on again for operation, it is required to confirm that the instrument has already been dried completely, avoiding any electrical short circuit or bodily injury resulting from the moisture.

---

## Appendix C: Battery Using Guide

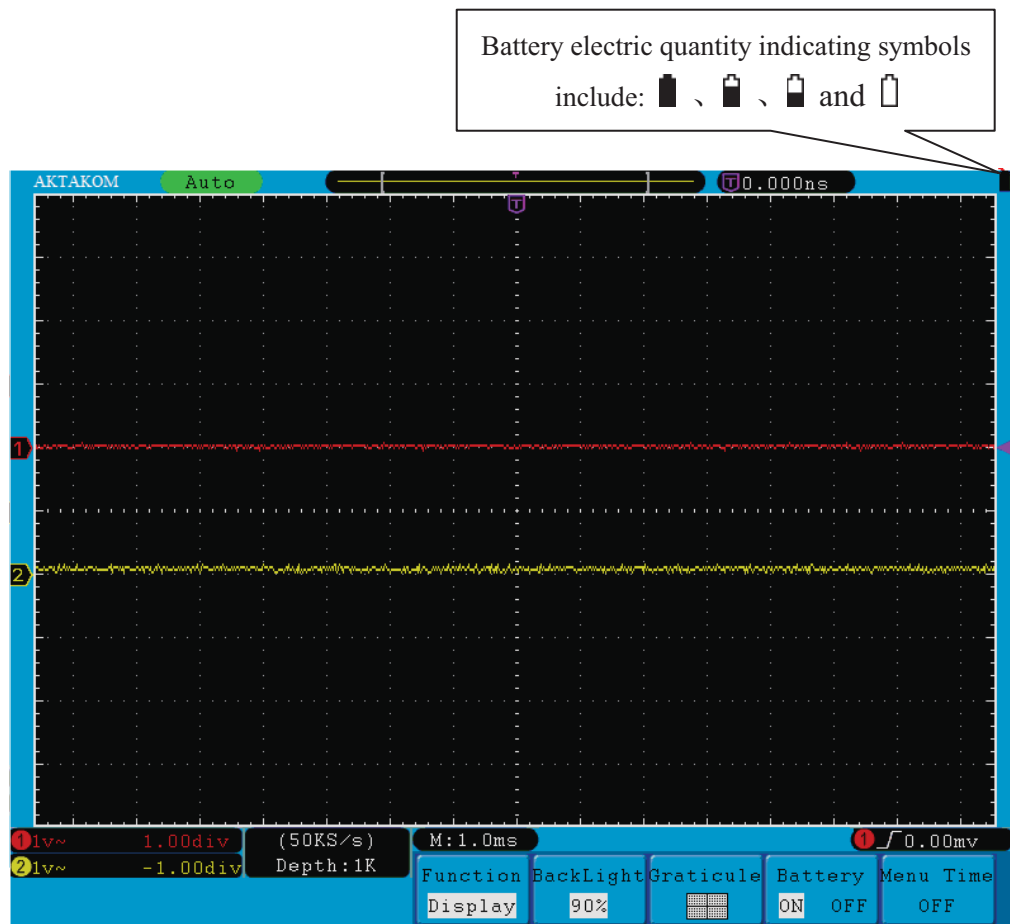







Fig.9-1 Battery power indication

### Charging the oscilloscope

Connect the power cord to a power source. Turn on the Power Switch Button  on the left side (make sure the “—” side is pressed down). Yellow light of the indicator on the front panel means the battery is being charged. Once the battery is full, the indicator will become green. The lithium battery maybe not be charged when delivery. Please charge the battery for 12 hours to make sure enough power to supply to oscilloscope. The battery can supply power for 4 hours after being charged completely.

There will have battery power indication show on the top of panel when oscilloscope power supplied by the battery ( if no indication has appeared, see “Display” on P55 ).

, ,  and  imply for different power consumption and when  shows it means the power can only supply for 5 minutes maximum.

### Note:

To avoid superheat of battery during charging, the environment temperature is not allowed to exceed the permissible value given in technical specification.

### Replacing the Lithium Battery Unit

It is usually not required to replace the battery unit. But when it is required to replace it, only qualified personnel can carry out this operation, and only use the same specification lithium battery.