



Clamp & Watt Meter ACM-2352

USER'S MANUAL



Introduction

Congratulations on your purchase of True RMS Clamp Meter. This meter measures AC Current, DC Current, AC/DC Voltage, Resistance, Capacitance, Frequency, Diode Test, Duty Cycle and Continuity. The molded case is designed for heavy duty use. This meter is shipped fully tested and calibrated and, with proper use, will provide years of reliable service.

Safety

International Safety Symbols



This symbol, adjacent to another symbol or terminal, indicates the user must refer to the manual for further information.



This symbol, adjacent to a terminal, indicates that, under normal use, hazardous voltages may be present

Double insulation



This **WARNING** symbol indicates a potentially hazardous situation, which if not avoided, could result in death or serious injury.



This **CAUTION** symbol indicates a potentially hazardous situation, which if not avoided, may result damage to the product.

PER IEC1010 OVERVOLTAGE INSTALLATION CATEGORY

OVERVOLTAGE CATEGORY I

Equipment of OVERVOLTAGE CATEGORY I is equipment for connection to circuits in which measures are taken to limit the transient overvoltages to an appropriate low level.

Note – Examples include protected electronic circuits.

OVERVOLTAGE CATEGORY II

Equipment of OVERVOLTAGE CATEGORY II is energy-consuming equipment to be supplied from the fixed installation.

Note – Examples include household, office, and laboratory appliances.

OVERVOLTAGE CATEGORY III

Equipment of OVERVOLTAGE CATEGORY III is equipment in fixed installations.

Note – Examples include switches in the fixed installation and some equipment for industrial use with permanent connection to the fixed installation.

OVERVOLTAGE CATEGORY IV

Equipment of OVERVOLTAGE CATEGORY IV is for use at the origin of the installation.

Note – Examples include electricity meters and primary over-current protection equipment

SAFETY NOTES

- Do not exceed the maximum allowable input range of any function.
- Do not apply voltage to meter when resistance function is selected.
- Set the function switch OFF when the meter is not in use.
- Remove the battery if meter is to be stored for longer than 60 days.

WARNINGS

- Set function switch to the appropriate position before measuring.
- When measuring volts do not switch to current/resistance modes.
- Do not measure current on a circuit whose voltage exceeds 600V.
- When changing ranges, always disconnect the test leads from the circuit under test.

CAUTIONS

- Improper use of this meter can cause damage, shock, injury or death. Read and understand this user manual before operating the meter.
- Always remove the test leads before replacing the battery or fuses.
- Inspect the condition of the test leads and the meter itself for any damage before operating the meter. Repair or replace any damage before use.
- Use great care when making measurements if the voltages are greater than 25VAC rms or 35VDC. These voltages are considered a shock hazard.
- Always discharge capacitors and remove power from the device under test before performing Diode, Resistance or Continuity tests.
- Voltage checks on electrical outlets can be difficult and misleading because of the uncertainty of connection to the recessed electrical contacts. Other means should be used to ensure that the terminals are not "live".
- If the equipment is used in a manner not specified by the manufacturer, the protection provided by the equipment may be impaired.
- This device is not a toy and must not reach children's hands. It contains hazardous objects as well as small parts that the children could swallow. In case a child swallows any of them, please contact a physician immediately
- Do not leave batteries and packing material lying around unattended; they can be dangerous for children if they use them as toys
- In case the device is going to be unused for an extended period of time, remove the batteries to prevent them from draining

- Expired or damaged batteries can cause cauterization on contact with the skin. Always, therefore, use suitable hand gloves in such cases
- See that the batteries are not short-circuited. Do not throw batteries into the fire.

Function	Maximum Input
A AC,	1500A DC/AC
A DC	1500A DC/AC
V DC, V AC	1000V DC/AC
Resistance, Capacitance, Frequency, Diode Test	250V DC/AC
Type K Temperature	30V DC, 24V AC

Description

Meter Description

1. Current clamp
2. Clamp opening trigger
3. RANGE Button
4. MODE button
5. MAX/MIN button
6. INRUSH button
7. Backlit LCD Display
8. Non-Contact Voltage Detector
9. NCV LED indicator
10. Function switch
11. KVA/KW/COS θ select button
12. Back light button
13. ZERO button
14. PEAK button
15. Multimeter input jacks

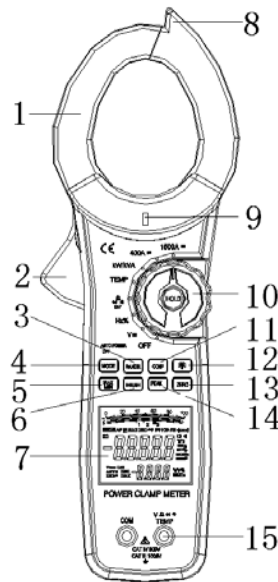

Display icons Description

- | | |
|-------------------------------|--|
| HOLD | Data Hold |
| APO | Auto Power Off |
| AUTO | Autoranging |
| | Peak Hold |
| DC | Direct Current |
| AC | Alternating Current |
| MAX | Max reading |
| MIN | Min reading |
| | Low battery |
| ZERO | DCA or CAP zero |
| mV or V | Milli-volts or Volts (Voltage) |
| Ω | Ohms (Resistance) |
| F | Farad (Capacitance) |
| Hz | Hertz (Frequency) |
| % | Duty Ratio |
| $^{\circ}$ F and $^{\circ}$ C | Fahrenheit and Celsius units (Temperature) |
| n, m, μ , M, k | Unit of measure prefixes: nano, milli, micro, mega, and kilo |
| | Continuity test |
| | Diode test |

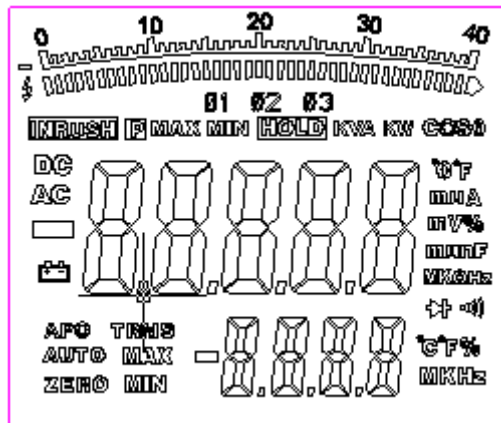

Operation

NOTES: Read and understand all **Warning** and **Caution** statements in this operation manual prior to using this meter. Set the function select switch to the OFF position when the meter is not in use.

Non-Contact Voltage Detector

WARNING: Risk of Electrocution. Before use, always test the Voltage Detector on a known live circuit to verify proper operation.

1. Rotate the Function switch to any measurement position.
2. Place the detector probe tip on the conductor to be tested.
3. If AC voltage is present, the NCV detector will turn on with a steady red light.

NOTE: The conductors in electrical cord sets are often twisted. For best results, move the probe tip along a length of the cord to assure placing the tip close to the live conductor.

NOTE: The detector is designed with high sensitivity. Static electricity or other sources of energy may randomly trip the sensor. This is normal operation.

AC/DC Current Measurements

WARNING: Disconnect the test leads before measuring with clamp.

1. Rotate the Function switch to the **1500A_{AC/DC}** position.
2. Press the **MODE** button to select AC or DC.
3. Press the trigger to open jaw. Fully enclose only one conductor.
4. Read the current value in the display.
5. If the value is less than 400A, rotate the function switch to the **400A_{AC/DC}** position to improve resolution.

DCA Zero

The Zero feature removes offset values and improves accuracy for DC current measurements. To perform a zero, select **Adc**, and, with no conductor in the jaw, press the **ZERO** button. The display will show zero. The offset value is now stored and removed from all measurements.

Frequency

When **ACV** is selected, the measured frequency can be viewed in the lower display.

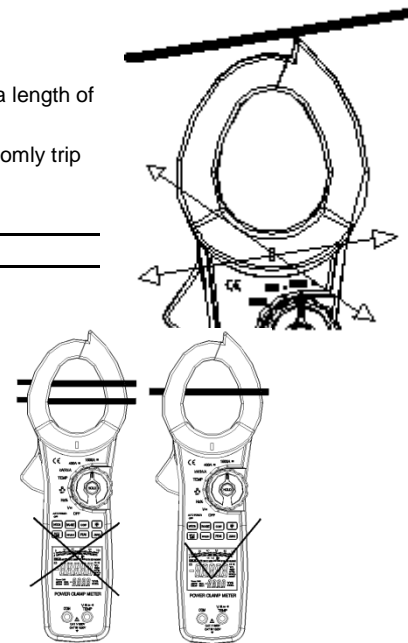

AC/DC Voltage Measurements

CAUTION: Do not measure voltages if a motor on the circuit is being switched ON or OFF. Large voltage surges may occur that can damage the meter.

1. Rotate the function switch to the **V** position.
2. Press the **MODE** button to select AC or DC Voltage.
3. Insert the black test lead banana plug into the negative **COM** jack. Insert the red test lead banana plug into the positive **V** jack.
4. Touch the black test probe tip to the negative side of the circuit. Touch the red test probe tip to the positive side of the circuit.
5. Read the voltage value in the display.

Frequency

When **ACA** is selected, the measured frequency can be viewed in the lower display.

Resistance Measurements

Note: Remove power from the device under test before measuring resistance.

1. Set the function switch to the **Ω** position.
2. Insert the black test lead banana plug into the negative **COM** jack. Insert the red test lead banana plug into the positive **V** jack.
3. Touch the black test probe tip to one side of the device to be measured. Touch the red test probe tip to the other side of the device to be measured.
4. Read the resistance value in the display.

Continuity Test

1. Connect as described for resistance measurements.
2. Press the **MODE** button to select continuity (ⓘ)).
3. Touch the test probe tips across the circuit or component under test.



- If the resistance is $< 50\Omega$, a tone will sound.

Diode Test

- Connect as described for resistance measurements
- Press the **MODE** button to select diode test $\rightarrow +$.
- Touch the test probe tips to the diode or semiconductor junction under test. Note the meter reading.

Reverse the test lead polarity by reversing the red and black leads. Note this reading. The diode or junction can be evaluated as follows: If one reading displays a value (typically 0.400V to 0.800V) and the other reading displays **OL**, the diode is good. If both readings display **OL** the device is open. If both readings are very small or '0', the device is shorted.

Capacitance Measurements

WARNING: To avoid electric shock, discharge the capacitor before measuring.

- Press the **MODE** button to select capacitance measurements.
- Insert the black test lead banana plug into the negative **COM** jack. Insert the red test lead banana plug into the positive $\rightarrow +$ jack.
- Touch the black test probe tip to one side of the device. Touch the red test probe tip to the other side of the device.
- Read the capacitance value in the display.

Note: For very large values of capacitance measurement time can be several seconds before the final reading stabilizes.

Note: The Zero feature removes stray test lead capacitance to improve the accuracy of low value capacitance measurements. To perform a zero, Press and hold the **MODE ZERO** button for two beeps. The display will zero. The offset value is now stored and is removed from all measurements.

Frequency and Duty Ratio Measurements

- Rotate the function switch to the **Hz %** Position.
- Insert the black test lead banana plug into the negative **COM** jack. Insert the red test lead banana plug into the positive **Hz** jack.
- Touch the black test probe tip to one side of the device. Touch the red test probe tip to the other side of the device.
- Read the Frequency value on the upper large display. Read the Duty Ratio on the lower small display.
- Press the **MODE** button to display the Duty Ratio on the large display.

Power and Measurement

- Rotate the function switch to the **KW/KVA** Position.
- The connecting method see right figure.
- Press the **MODE** button to select AC or DC power.
- Press **COS θ** button to select KVA, KW, or Power Factor.

Type K Temperature Measurements

- Rotate the function switch to the **Temp** position.
- Press the **MODE** button to select °F or °C.
- Plug the transfer socket into the negative **COM** jack and the positive **V** jack, then insert the TYPE K into the transfer socket, make sure that the positive and negative feet are connected correctly.
- Connect the temperature probe tip(s) to the object which will be tested.
- Read the temperature on the display.

Note: In case of an open input or a temperature overrange, the meter will display "----".

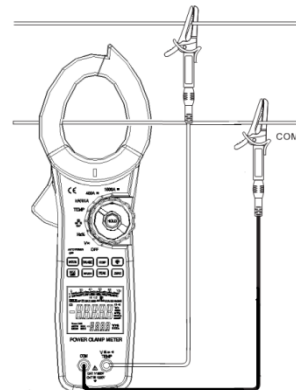

Data Hold

To freeze the LCD reading, press the **HOLD** button. While data hold is active, the **HOLD** icon appears on the LCD. Press the **HOLD** button again to return to normal operation.

MAX/MIN

- Press the **MAX/MIN** button to activate the MAX/MIN recording mode. The display icon "**MAX**" will appear. The meter will begin recording and displaying the maximum value measured.
- Press the **MAX/MIN** button and "**MIN**" will appear. The meter will display the minimum value measured during the recording session.
- Press the **MAX/MIN** button and "**MAX MIN**" will appear. The meter will display the present reading, but will continue to update and store the max and min readings.
- To exit MAX/MIN mode press and hold the **MAX/MIN** button for 2 seconds.

Peak Hold

When ACA or ACV is selected, pressing the **PEAK** button enables the peak capture circuit. The meter will now capture and display the maximum and minimum peaks of the waveform.

INRUSH

When ACA is selected, press the **INRUSH** button to activate the inrush capture circuit.

A transient condition, generally lasting 110-120 milliseconds that occurs during motor start-up.

RANGE

In the Voltage, Resistance, Capacitance, Frequency or uA function the meter automatically selects the best range for the measurements being made. For measurement situations requiring that a range be manually selected, perform the following:

1. Press the **RANGE** button. The "AUTO" display icon will turn off.
2. Press the **RANGE** key to step through the available ranges. Observe the decimal point and units displayed until the preferred range is located.
3. To exit the Manual Ranging mode and return to Autoranging, press and hold the **RANGE** key for 2 seconds.

COS θ

In power mode, Press **COS θ** button to select KVA ,KW, or Power Factor.

LCD Backlight

The LCD is equipped with backlighting for easier viewing, especially in dimly lit areas. Press  to turn the backlight on. The backlight will automatically turn off after 30 seconds.

Automatic Power OFF with Disable

In order to conserve battery life, the meter will automatically turn off after approximately 30 minutes. To turn the meter on again, turn the function switch to the OFF position and then turn to the desired function position.

To disable APO:

1. From the OFF position, hold the MODE button and rotate the FUNCTION switch to a measurement function.
2. **APO**  will appear in the display
3. Release the MODE button
4. APO is now disabled (APO icon is off) and will be reset when the Function switch is returned to the OFF position.

Low battery indication

When the  icon appears in the display, the battery should be replaced. Refer to the battery replacement procedure in the maintenance section.

Maintenance

WARNING: To avoid electrical shock, disconnect the meter from any circuit, remove the test leads from the input terminals, and turn OFF the meter before opening the case. Do not operate the meter with an open case.

Cleaning and Storage

Periodically wipe the case with a damp cloth and mild detergent; do not use abrasives or solvents. If the meter is not to be used for 60 days or more, remove the battery and store it separately.

Battery Replacement

1. Remove the Phillips head screw secures the rear battery door.
2. Open the battery compartment
3. Replace the 9V battery
4. Secure the battery compartment door with the screw



You, as the end user, are legally bound (**Battery ordinance**) to return all used batteries and accumulators; **disposal in the household garbage is prohibited!**

You can hand over your used batteries / accumulators, gratuitously, at the collection points for our branches in your community or wherever batteries / accumulators are sold!

Disposal



Follow the valid legal stipulations in respect of the disposal of the device at the end of its lifecycle

Specifications

Function	Range& Resolution	Accuracy (% of reading)
DC Current	400.00 ADC	± (2.0% +30digits)
	1500.0 ADC	± (2.5% +30digits)
AC Current True RMS (50Hz to 60 Hz)	400.00 AAC	± (2.5% +30digits)
	1500.0 AAC	± (2.8% +30digits)
All AC voltage ranges are specified from 5% of range to 100% of range		
DC Voltage	400.00 mVDC	± (0.1% + 9digits)
	4.0000VDC	± (0.1% + 4 digits)
	40.000 VDC	
	400. 00 VDC	
1000.0 VDC	± (0.5% + 4 digits)	
AC Voltage True RMS (50 Hz to 1000 Hz)	400.0 mVAC	± (0.8% + 9digits)(50/60Hz)
	4.0000 VAC	± (1.0% + 30 digits)
	40.000 VAC	
	400. 00 VAC	
	750.0 VAC	
All AC voltage ranges are specified from 5% of range to 100% of range		
Resistance	400.00 Ω	± (0.5% + 9 digits)
	4.0000KΩ	± (1.0% + 4 digits)
	40.000KΩ	
	400.00KΩ	
	4.0000MΩ	± (2.0% + 10digits)
40.000MΩ	± (3.0% + 10 digits)	
Capacitance	400.00nF	±(3.5% reading + 40digits)
	4000.0nF	±(3.5% reading + 10digits)
	40.000µF	
	400.00µF	
	4.0000mF	±(5% reading + 10 digits)
	20.000mF	Not specified
Frequency	40.000 Hz	±(0.3% reading + 2 digits)
	400.00 Hz	
	4.0000KHz	
	40.000KHz	
	400.00KHz	
	4.0000MHz	
	40.000MHz	
	Sensitivity: 0.8V rms min. @ 20% to 80% duty cycle and <100kHz; 5Vrms min @ 20% to 80% duty cycle and > 100kHz.	
Duty Cycle	10.0 to 95.0%	±(1.0% reading + 2 digits)
	Pulse width: 100µs - 100ms, Frequency: 10Hz to 100kHz	
Temp (type-K) (probe accuracy not included)	-100.0 to 1000.0°C	±(1.0% reading + 2.5 °C)
	-148.0 to 1832.0°F	±(1.0% reading + 4.5°F)
(probe accuracy not included)		
AC KW/kVA(0-600V,0-1500A,50/60Hz TRMS)	900.0kW	± (3% +10digits)
	All AC voltage ranges are specified from 5% of range to 100% of range	
DC KW/kVA(0-600 V,0-1500A)	900.0kW	± (2.8 % +10digits)

General Specifications

Clamp jaw opening	2.0" (52mm) approx.
Display	Dual 40,000/4,000 count backlit LCD
Continuity check	Threshold 50Ω; Test current < 0.5mA
Diode test	Test current of 0.3mA typical; Open circuit voltage [2.8VDC typical
Low Battery indication	Battery symbol is displayed
Over-range indication	'OL' display
Measurement rate	2 readings per second, nominal
Peak detector	>1ms
Thermocouple sensor	Type K thermocouple required
Input Impedance	10MΩ (VDC and VAC)

AC bandwidth	50 to 400Hz (AAC and VAC)
AC response	True rms (AAC and VAC)
Crest Factor	3.0 in 40A and 400A ranges, 1.4 in 1000A range (50/60Hz and 5% to 100% of range)
Operating Temperature	5°C to 40°C (41°F to 104°F)
Storage Temperature	-20°C to 60°C (-4°F to 140°F)
Operating Humidity	Max 80% up to 31°C (87°F) decreasing linearly to 50% at 40°C (104°F)
Storage Humidity	<80%
Operating Altitude	7000ft. (2000meters) maximum.
Battery	One (1) 9V Battery (NEDA 1604)
Auto power OFF	After approx. 30 minutes
Dimensions & Weight	11.57x4.13x1.85" (294x105x47mm); 18.9 oz. (536g)
Safety	For indoor use and in accordance with the requirements for double insulation to IEC1010-1 (2001): EN61010-1 (2001) Overvoltage Category III 600V and Category II 1000V, Pollution Degree 2.
Approvals	CE